

EXTEND CONNECTION BALL VALVE – Without Mounting Pad

N-3BL



Technical Data

Full Port, 3 piece type

Material: Wetted parts ASTM A351 CF8M / 316

Connection Size: ¼”(8mm), ⅜”(10mm), ½”(15mm), ¾”(20mm), 1”(25mm), 1¼”(32mm), 1½”(40mm), 2”(50mm), 2½”(65mm), 3”(80mm), 4”(100mm)

Connection Type: Long butt weld ends

Locking Device: Valve operated locking in open or closed position

Blow-Out Proof Stem & Solid Ball

Working Temperature Limited: -20°F ~ 350°F (-5°C ~ 175°C)

Working Pressure Limited: 1000psi (70kg/cm²) for ¼”~1”; 800psi (56kg/cm²) for 1¼”~2”; 600psi (42kg/cm²) for 2½”~4”

Valves inspected and tested according to **API 598 standard**.

Dimensions

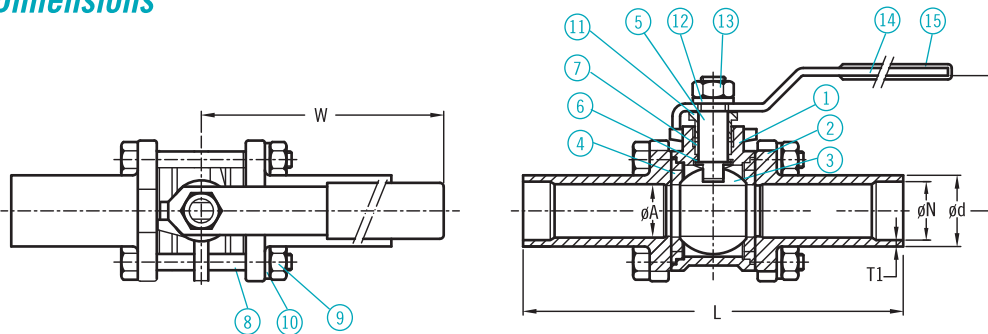

unit=mm

mm	Size inch	A±0.3	L±2.0	H±3.0	W±3.0	øN±0.3	ød±0.3	T1	TORQUE Inch/Lbs
08	¼	10	160	52	103	13.6	16.8	1.6	70
10	⅜	12.5	160	52	103	13.6	16.8	1.6	70
15	½	15	180	55	103	18.1	21.3	1.6	80
20	¾	20	180	63	103	23.7	26.9	1.6	110
25	1	25	192	70	135	30.1	33.7	1.8	160
32	1¼	32	205	72	135	38.4	42.4	2.0	220
40	1½	38	230	89	180	44.3	48.3	2.0	400
50	2	50	243	97	180	55.3	60.3	2.5	450
65	2½	65	294	143	260	70.1	76.1	3.0	650
80	3	80	320	152	260	82.9	88.9	3.0	930
100	4	100	346	188	400	108.3	114.3	3.0	1100

Parts List

Item	Parts Name	Material	Item	Parts Name	Material
1	Body	ASTM A351 CF8M / 316	9	Hex Nut	AISI 304
2	Cap	ASTM A351 CF8M / 316	10	Bolt Washer	AISI 301
3	Ball	ASTM A351 CF8M / 316	11	Gland	AISI 304
4	Seat	PTFE	12	Washer	AISI 304
5	Stem	AISI 316	13	Nut	AISI 304
6	Thrust Washer	PTFE	14	Handle	AISI 304
7	Stem Packing	PTFE	15	Plastic Cover	Plastic
8	Bolt	AISI 304			

Pressure–Temperature

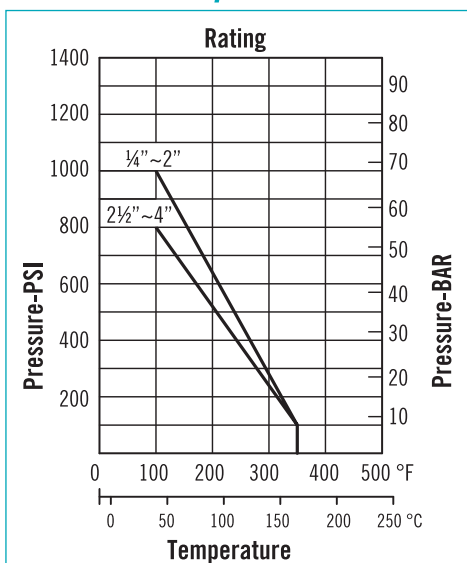

Ordering Information

N-3BL	Code	Model
	L	Long Butt Weld Ends
		Code Body Material
	S	CF8M / SS316
		Code Connection Size
		(A) ¼” (B) ⅜” (C) ½” (D) ¾” (E) 1” (F) 1¼”
		(G) 1½” (H) 2” (I) 2½” (J) 3” (K) 4”
N-3BL		Complete Ordering Code