

FOR LIQUIDS

EasyTREK/EchoTREK

ULTRASONIC LEVEL TRANSMITTERS



3 YEARS WARRANTY @ NIVELCO – WHERE ELSE?

NIVELCO

LEVEL TRANSMITTERS

EasyTREK / EchoTREK ULTRASONIC LEVEL TRANSMITTERS FOR LIQUIDS

MAIN FEATURES

- 2- /4-wire compact and 2-wire integrated level transmitters
- Non-contact level measurement
- Maximum 25 m (82 ft) measuring range
- Narrow (5°) beam angle
- Full temperature compensation
- IP68 rated integrated (blind) type
- Plug-in display unit for the compact types
- HART communication
- Ex version

APPLICATIONS

- For most liquids, including flammable liquids
- Open channel flow metering
- Wide application area from wastewater to aggressive chemicals
- Level measurement in basins, wells, sumps, lift-stations
- Suitable for level measurement of hydrocarbons, acids, aggressive liquids, any water based medium



GENERAL DESCRIPTION

The **EasyTREK** and **EchoTREK** high performance level transmitters are based on **NIVELCO**'s 30 years of experience with ultrasonic level measurement. Whether for liquid level measurement in sumps or tanks, for tank contents measurement, or open channel flow measurement, **EasyTREK** and **EchoTREK** transmitters provide the answer. Installed on the tank roof, or above the liquid surface to be measured, the transmitters give analogue output proportional to liquid level or transmit HART digital data. The **EchoTREK** is an intelligent compact ultrasonic level transmitter with 4-20 mA output offering HART protocol as option. Local reading is ensured by a plug-in display which can be removed if displaying is not needed. Four keys provide for programming, both display and keys are located under a removable cover. The unit is tank-top mountable only. The **EasyTREK** is an integrated, blind transmitter with equal measuring performance as the **EchoTREK** but readable and programmable remotely only through HART protocol coming as standard. The two mounting options of the **EasyTREK**: 1 1/2" and 2" process connections as its bottom or flanges for a mounting on the top of the tank. Its 1" threaded neck facilitates suspending it above the medium, a typical water / wastewater application.

Both models can be used in multi-drop systems connected to **NIVELCO**'s **MultiCONT** process controller/display, or to a PC with the help of the **UNICOMM** HART USB/RS485 modem or similar. **EasyTREK** and **EchoTREK** are available with measurement ranges up to 25 m (82 ft) providing wide application possibilities. Both ultrasonic level transmitters are using **NIVELCO**'s established SenSonic range transducers with a full beam angle of 5 to 7 degrees connected to the intelligent electronics featuring the **QUEST+** advanced signal processing algorithm.

OPERATION

The ultrasonic level metering technology is based on the principle of measuring the time required for the ultrasound pulses to cover the distance from the sensor to the level to be measured and back. The echoes bounced back from the surface of the medium to be measured reach the sensor surface after the time of flight of the ultrasonic impulse. The time of flight of the reflected signal is measured and processed by the electronics, and then this is converted to distance, level, volume or flow proportional data with the help of the customizable tank dimensions or the pre-programmed flume / weir parameters. The intelligent **QUEST+** process adaptive signal processing software system ensures that the electronics identifies and validates the liquid surface signal, giving reliable level monitoring.

TRANSDUCERS

Transducer material	EasyTREK	EchoTREK	
	SP-300	SE/SG-300	ST/SB-400
PP (Polypropylene)	■	■	■
PVDF (KYNAR)	■	■	■
PTFE (Teflon)	■	■	■
1.4571 (316 Ti) stainless steel	-	■	■

Functions	EasyTREK	EchoTREK	
	SP-300	SE/SG-300	ST/SB-400
Relay	■	■	■
HART	■	■	■
IrDA	■	■	■
Logger	■	■	■
Intrinsically safe version	■	■	-
Display	-	SAP-200	



TECHNICAL DATA

Type	EasyTREK SP-300	EchoTREK SE/SG-300	EchoTREK ST/SB-400
System	2-wire		4-wire
Accuracy (1)	± (0.2 % of measured distance +0.05 % of range)		
Resolution	Depending on the measured distance: <2 m (6.5 ft): 1 mm (0.04 inch); 2 ... 5 m (6.5 ... 16.5 ft): 2 mm (0.075 inch); 5 ... 10 m (16.5 ... 33 ft): 5 mm (0.2 inch); >10m (33 ft): 10 mm (0.4 inch)		
Output	Analogue	4-20 mA	
	Relay (2)	SPDT, 30 V DC, 1A DC	#1 SPDT, 250 V AC, 3 A AC1 #2 SPDT, 30 V DC, 1 A DC
	Display	–	SAP-200: 6-digit plug-in LCD display
	Digital Communication	4-20 mA + HART	
Ambient temperature	-30 °C ... +80 °C (-22 °F ... +176 °F)	with plastic housing: -25 °C ... +70 °C (-13 °F ... +158 °F) with metal housing: -30 °C ... +70 °C (-22 °F ... +158 °F) with display: -25 °C ... +70 °C (-13 °F ... +158 °F)	
	Ex version: see „Special data for Ex certified models“ table		
Medium temperature	see “Special data of the transducers” table, Ex version: see „Special data for Ex certified models“ table		
Medium pressure	0.03 ... 0.3 MPa (0.3 ... 3 bar g / 7.5 ... 43.5 psi g)	0.03 ... 0.3 MPa (0.3 ... 3 bar g / 7.5 ... 43.5 psi g), with stainless steel transducer: 0.09 .. 0.11 MPa (0.9 ... 1.1 bar g / 13 ... 16 psi g)	
Power supply	12...36 V DC / 48 ...720 mW		85...255 V AC / 2 VA 20...28 V AC/DC / 3 VA/3 W
Electrical protection	in case of DC power supply: Class III.		
	in case of AC power supply: with metal housing: Class I. with plastic housing: Class II.		
Housing	Polypropylene (PP) or KYNAR (PVDF) same as the transducer material; In case of Teflon (PTFE) transducer the housing material is PP	Paint coated aluminium, plastic (PBT)	
Sealing	In case of PP transducer: EPDM; all the other transducers: FPM (Viton)		
Electrical connection	LiYCY 2x 0.5 mm ² (AWG20) shielded Ø 6 mm (0.25 in) cable; standard cable length: 5 m (16.5 ft) (can be ordered up to 30 m (100 ft))	2xM20x1.5 cable glands + internal thread for 2x ½” NPT cable protective pipe, cable outer diameter: Ø6...Ø12 mm (0.25...0.45 inch), wire cross section: max.1.5 mm ² (AWG15) Ex version: See „Special data for Ex certified models“ table	
Ingress protection	IP68	Transducer: IP68, Housing: IP67	
Explosion protection	See „Special data for Ex certified models“ table		–
Mass	1.2 – 2 kg (2.65 – 4.4 lb)	1.3 – 2.3 kg (2.85 – 5 lb)	

(1) Under optimum conditions and stabilized transducer temperature

(2) The 4-wire EchoTREK transmitters have two parallel operating relays

SPECIAL DATA FOR Ex CERTIFIED MODELS

Type	EasyTREK SP-300	EchoTREK SE/SG-300
Protection type	Intrinsically safe	
Ex marking	II 1G EEx ia IIB T6	
Intrinsically safe data	$U_{MAX} = 30 V, I_{MAX} = 140 mA, P_{MAX} = 1 W, C_i = 15 nF, L_i = 0.2 mH$	
Ambient temperature	-20 °C ... +70 °C (-4 °F... +158 °F)	with plastic housing: -20 °C ... +70 °C (-4 °F... +158 °F), with metal housing: -30 °C ... +70 °C (-22 °F ... +158 °F), with display: -25 °C ... +60 °C (-13 °F ... +140 °F)
Medium temperature	with PP transducer: -20 °C...+70 °C (-4 °F...+158 °F), with PVDF transducer: -20 °C...+80 °C (-4 °F...+176 °F) with stainless steel transducer: -30 °C...+100 °C (-22 °F...+212 °F)	
Electrical connection	LiYCY type 2x 0.5 mm ² (AWG20) shielded Ø 6 mm (0.25 in) cable; standard cable length: 5 m (16.5 ft) (can be ordered up to 30 m (100 ft))	2x M20 x1.5 metal cable glands

ULTRASONIC LEVEL TRANSMITTERS IN HART MULTIDROP LOOP

The MultiCONT processes and displays measurement data supplied by NIVELCO's HART equipped transmitters connected to a Multidrop loop. Up to 15 transmitters (also mixed models) can be connected and remote programming can be also performed through the MultiCONT. Re-transmission of the data is possible via RS485 communication line to a PC or PLC when needed.

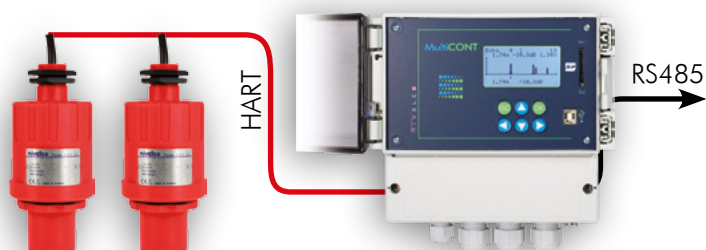

SPECIAL DATA OF THE TRANSDUCERS

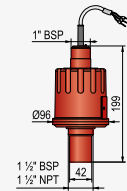
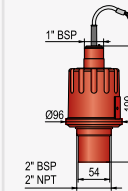
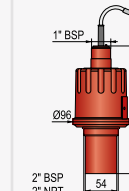
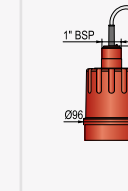
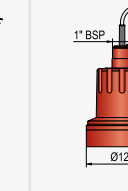
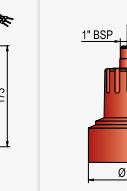
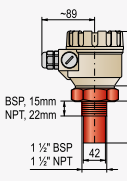
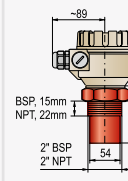
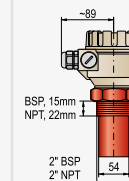
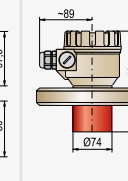
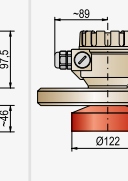
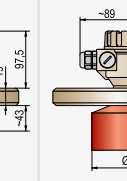
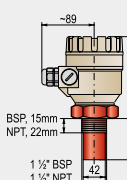
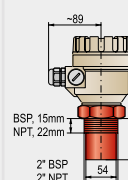
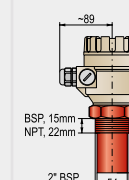
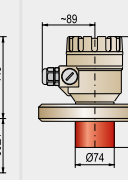
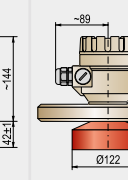
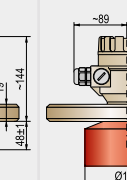
Transducer type	□□-39/49	□□-38/48	□□-37/47	□□-36/46	□□-34/44	□□-32/42
Beam angle	6°	5°	7°		5°	7°
Transducer material	PP or PVDF					
EasyTREK SP 2-wire						
Process connection	1" BSP and 1 1/2" BSP or NPT	1" BSP and 2" BSP or NPT			1" BSP	
EchoTREK SE/SG 2-wire						
EchoTREK ST/SB 4-wire						
Process connection	1 1/2" BSP / NPT	2" BSP / NPT		DN 80 flange	DN 125 flange	DN 150 flange
Max. measuring range (1)	4 m (13 ft)	6 m (20 ft)	8 m (26 ft)	10 m (33 ft)	15 m (50 ft)	25 m (82 ft)
Min. measuring range (1)	0.2 m (0.65 ft)	0.25 m (0.82 ft)	0.35 m (1.15 ft)		0.45 m (1.5 ft)	0.6 m (2 ft)
Medium temperature	-30 °C ... +90 °C (-22 °F ... +194 °F)					
Recommended applications	Small vessels with 1 1/2" or 2" process connection			Small vessels with flange	Mid-size vessels with flange	Tall vessels with flange

Transducer material	PTFE			Stainless steel		
Max. measuring range (1)	3 m (10 ft)	5 m (16.5 ft)	6 m (20 ft)	7 m (23 ft)	12 m (40 ft)	15 m (50 ft)
Min. measuring range (1)	0.25 m (0.82 ft)		0.35 m (1.15 ft)	0.4 m (1.3 ft)	0.55 m (1.8 ft)	0.65 m (2.15 ft)
Medium temperature	-30 °C ... +90 °C (-22 °F ... +194 °F)			-30 °C ... +100 °C (-22 °F ... +212 °F) (CIP 120 °C (248 °F) for max. 2 hours)		

(1) Under optimum conditions and stabilized transducer temperature

Suitable mounting brackets

Material: Plastic (PP) internal part / paint coated iron bracket

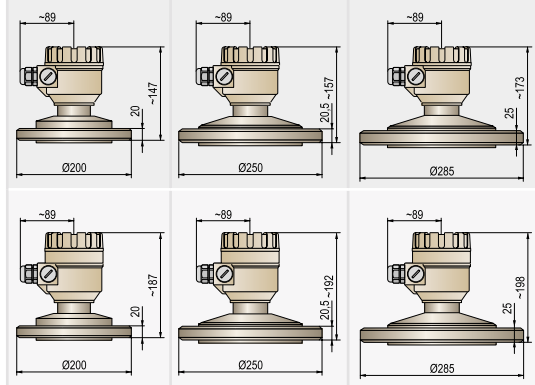
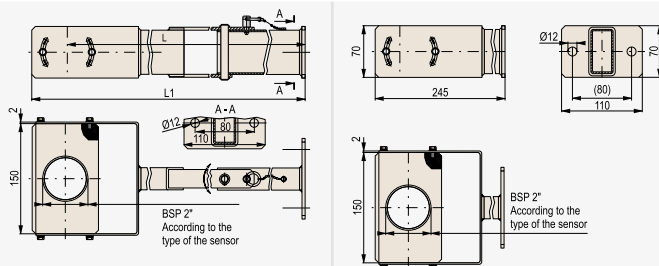

WIRING

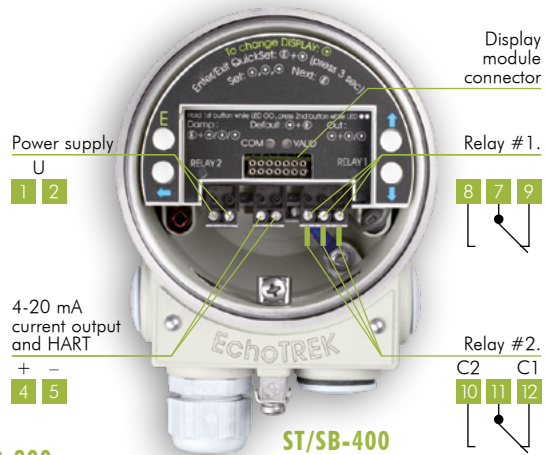
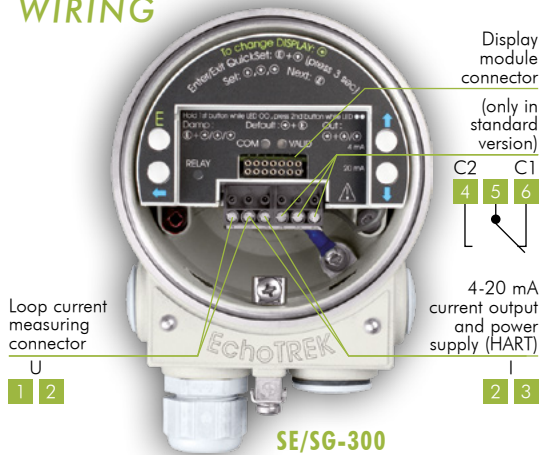

DISPLAY

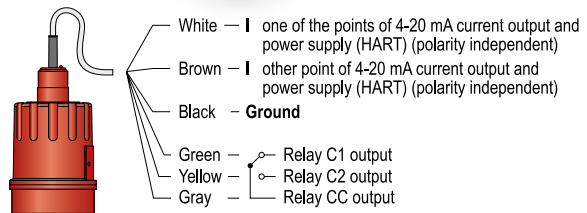

ECHO MAP WITH MultiCONT

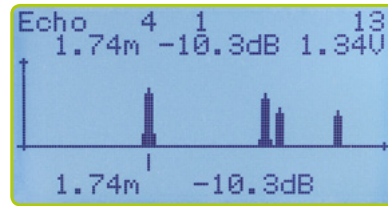

TREND MONITORING WITH EView2

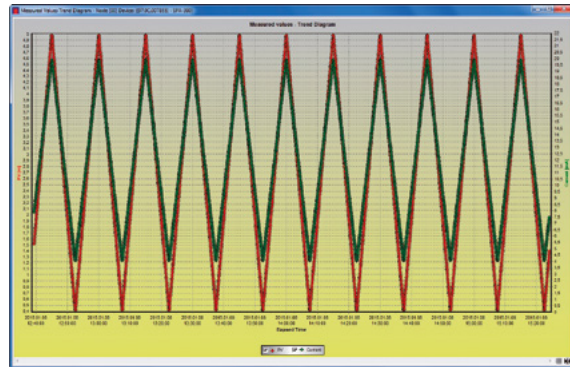

With the help of the SAP-200 plug-in display a full-parameter programming can be accomplished, the parameters of measurement and output can be set using the alphanumeric display module. The large LCD display displays the measured values in numerical and bar graph form. The display features indication for the infrared communication (IrDA) port which provides possibility for logger readout, diagnostics and software upgrade. The MultiCONT multichannel process controller / display unit is able to visualize the Echo Map. The Echo Map feature helps to detect false reflections and aids the optimization of the measurement configuration.

ACCESSORIES

Separately orderable PP plastic flanges

SFA - 3 ■ ■ - 0

DIN flanges	Code	RF ANSI flanges	Code	JIS flanges	Code	For units with	Code
DN80 PN16	2	3" FF 150 psi	A	10K 80A	G	1" BSP thread	1
DN100 PN16	3	4" FF 150 psi	B	10K 100A	H	2" BSP thread	3
DN125 PN16	4	5" FF 150 psi	C	10K 125A	P	2" NPT thread	4
DN150 PN16	5	6" FF 150 psi	D	10K 150A	R	1½" BSP thread	6
DN200 PN16	6	8" FF 150 psi	E	10K 200A	S	1½" NPT thread	7
DN250 PN16	7	12" FF 150 psi	Y	10K 300A	Z		
DN300 PN16	8						

ORDER CODES (NOT ALL COMBINATIONS AVAILABLE)

EasyTREK integrated compact ultrasonic level transmitters for liquids

EasyTREK S -3 - (1)

Type	Code	Transducer material	Code	Measuring range	Code	Process Connection	Code	Output / Ex	Code
Integrated	P	PP	A	25 m (82 ft) (2)	2	1" BSP thread	0	Without Logger	4
		PVDF	B	15 m (50 ft)	4	1 1/2" or 2" NPT and 1" BSP (6)	N	Ex	8
		PTFE	T	10 m (33 ft)	6			relay	H
				8 m (26 ft) (3)	7			4-20 mA + HART	3
				6 m (20 ft) (4)	8			Ex	7
				4 m (13 ft) (5)	9			relay	A

EchoTREK compact ultrasonic level transmitters for liquids

EchoTREK S (1)

Type	Code	Transducer material	Code	Series	Code	Proc. Conn.	Code	Output / Ex	Code
2-wire		With metal housing		2-wire	3	BSP thread	0	2-wire	
Transmitter	E	PP	A	4-wire	4	NPT thread	N	Without Logger	2
Transmitter + display	G	PVDF	B			PP plastic DIN flanges (PN16)	DN80 2 DN100 3 DN125 4 DN150 5 DN200 6	4-20 mA	HART 4 Ex 6 HART / Ex 8 relay R HART + relay H
4-wire		PTFE	T	Measuring range	Code	3" FF	A	With Logger	
Transmitter	T	Stainless steel	S	25 m (82 ft) (2)(7)	2	4" FF	B	4-20 mA	HART 3 Ex 5 HART / Ex 7 relay L HART + relay A
Transmitter + display	B	With plastic housing		15 m (50 ft) (8)	4	5" FF	C	Output / Power supply	
		PP	P	10 m (33 ft) (9)	6	6" FF	D	4-wire (10)	
		PVDF	V	8 m (26 ft) (3)	7	8" FF	E	85-255 V AC	1
		PTFE	F	6 m (20 ft) (4)	8	80A	G	8-20 mA + 2x relay	HART 3 Logger K HART + Logger G
		Stainless steel (2)	M	4 m (13 ft) (5)	9	100A	H	24 V AC/DC	2
						125A	P	4-20 mA	HART 4 Logger L HART + Logger H
						150A	R		
						200A	S		
						Mounting bracket	200 mm K 500 mm L 700 mm M		

- (1) The order code of an Ex version should end in "Ex"
- (2) Ex version not available
- (3) With PTFE sensor: 6 m (20 ft)
- (4) With PTFE sensor: 5 m (16.5 ft)
- (5) With PTFE sensor: 3 m (10 ft)
- (6) Only with SP-37, SP-38 and SP-39 units
- (7) With stainless steel sensor: 15 m (50 ft)
- (8) With stainless steel sensor: 12 m (40 ft)
- (9) With stainless steel sensor: 7 m (23 ft)
- (10) Two parallel operating relays

ACCESSORIES

Accessories	Order Code
Plug-in display module	SAP-200
Multichannel process controller and display unit	MultiCONT P-200
24V DC power supply module, DIN rail mountable	NIPOWER PPK-331
Intrinsically safe isolator power supply module, DIN rail mountable	UNICONT PGK-301 Ex
HART- USB/RS485 modem for remote programming with PC, DIN rail mountable	UNICOMM SAK-305
HART- USB modem for remote programming with PC	UNICOMM SAT-304
EView2 configuration software for remote programming with PC	FREE download!

Accessories

Accessories	Order Code
Fast connecting gland for pipe mounting, 1", PP	SAA-101
Damping gland for mounting the devices to thin metal roofs, PP	SAA-106
Transparent gland for pipe extension	SAA-110

Separately orderable mounting brackets

For units with BSP thread process connection	Order Code
1"	200 mm (7 7/8 in) SAA-107-0 500 mm (1.65 ft) SAA-108-0 700 mm (2.3 ft) SAA-109-0
2"	200 mm (7 7/8 in) SAA-107-3 500 mm (1.65 ft) SAA-108-3 700 mm (2.3 ft) SAA-109-3
1 1/2"	200 mm (7 7/8 in) SAA-107-4 500 mm (1.65 ft) SAA-108-4 700 mm (2.3 ft) SAA-109-4

