

BATCH CONTROLLER

WITH TWO STAGE CONTROL AND ANALOG OUTPUT
IN RELATION TO THE BATCH PROCESS



Features

- Large display shows preset value and running batch value simultaneously.
- The analog output value reflects the course of the batch process; fourteen different profiles can be selected.
- Self-learning overrun correction.
- Easy operation to enter a batch value and to control the process.
- Count-up and count-down function available.
- Ability to process all types of flowmeter signals.
- Operational temperature -40°C up to +80°C (-40°F up to 176°F).
- Very compact design for panel mount, wall mount or field mount applications.
- Rugged aluminum field mount enclosure IP67/NEMA4X.
- Intrinsically Safe - ATEX and IECEx approval for gas and dust applications.
- Explosion/flame proof Ex II 2 GD EEx d IIB T5.
- Full Modbus communication RS232/485/TTL.
- Loop or battery powered, 8 - 24V AC/DC or 115 - 230V AC power supply.
- Sensor supply 3.2 / 8.2 / 12 / 24V DC.

Signal output

- Two configurable control outputs: for two-stage or one-stage control.
- (0)4 - 20mA / 0 - 10V DC according to the batch process.
- Scaled pulse output according to acc. total.

Signal input

Flow

- Reed-switch.
- NAMUR.
- NPN/PNP pulse.
- Sine wave (coil).
- Active pulse signals.
- (0)4 - 20mA.
- 0 - 10V DC.

Status

- Remote control: start.
- Remote control: pause / stop.

Applications

- For batch applications where retransmission of the course of the process is required. Alternative basic model: F030, F130 and F131 or more sophisticated models: 300 series.

General information

Introduction

The F136 offers in addition to the standard functions an analog output signal in relation to the batch process. This to transmit the course of the process.

The operator can enter a batch quantity easily or execute repeating batches. During the batch, the preset value is displayed as well as the batched (or remaining) quantity. The automatic self-learning overrun correction ensures an accurate result after each batch.

Display

The display has large 17mm (0.67") and 8mm (0.31") digits. Besides the process information, a seven digit resettable "day total" is available as well as an eleven digit non-resettable accumulated total. All values are backed-up in EEPROM memory every minute.

Configuration

All configuration settings are accessed via a simple operator menu which can be pass-code protected. Each setting is clearly indicated with an alphanumeric description, therefore avoiding confusing abbreviations and baffling codes. All settings are safely stored in EEPROM memory in the event of sudden power failure.

Analog output signal

The (0)4 - 20mA or 0 - 10V DC output signal is related to the batch process. For example, a 4mA will be generated when START has been pressed and this value will increase smoothly to 18.7mA when the overrun correction closes the valve. The end value will be 20mA when the batch is finished. Fourteen different profiles are available to re-transmit the course of the process (see section profiles). The output signal can be passive, active or isolated where the passive output type will loop power the F136 as well.

Control outputs

Two outputs are available which can be configured to operate as two stage control for large batch quantities or as one stage control for smaller batches, where the second output is available as a scaled pulse output.

The output signals can be passive NPN, active PNP or an isolated electro-mechanical relay.

Signal input

The F136 will accept most pulse and analog input signals for volumetric flow or mass flow measurement. The input signal type can be selected by the user in the configuration menu without having to adjust any sensitive mechanical dip-switches or jumpers.

Communication

All process data and settings can be read and modified manually or through the Modbus communication link (RS232 / RS485). If desired, the batch process can even be started and stopped through communication.

Full Modbus functionality remains available for the Intrinsically Safe version (TTL).

Hazardous areas

This model has been ATEX and IECEx certified Intrinsically Safe for gas and dust applications, with an allowed operational temperature of -40°C to +70°C (-40°F to +158°F).

A flame proof enclosure with ATEX certification offers the rating Ex II 2 GD EEx d IIB T5.

Enclosures

Various types of enclosures can be selected, all ATEX and IECEx approved. As standard the F136 is supplied in an GRP panel mount enclosure, which can be converted to an field mount enclosure. Most popular is our rugged aluminum field mount enclosure with IP67 / NEMA 4X rating. Both European or U.S. cable gland entry threads are available.

Overview application F136

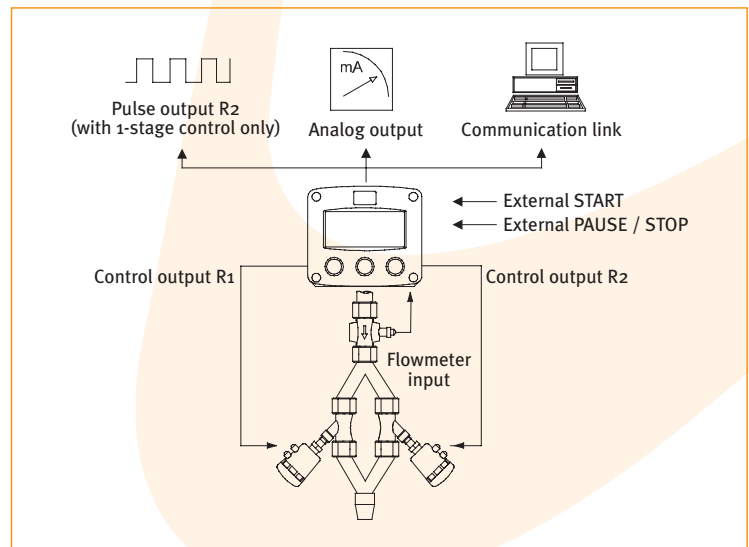

Dimensions enclosures

Aluminum & GRP panel mount enclosure

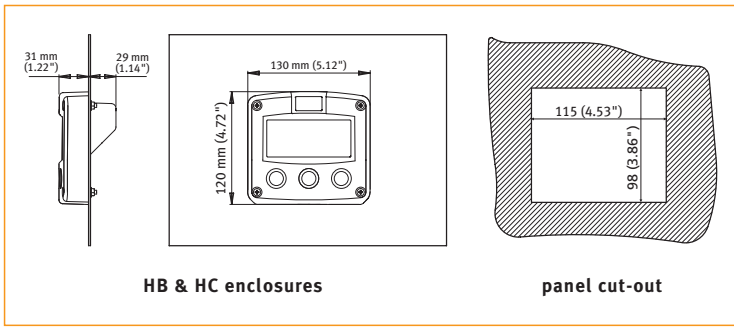

Aluminum & GRP field / wall mount enclosures

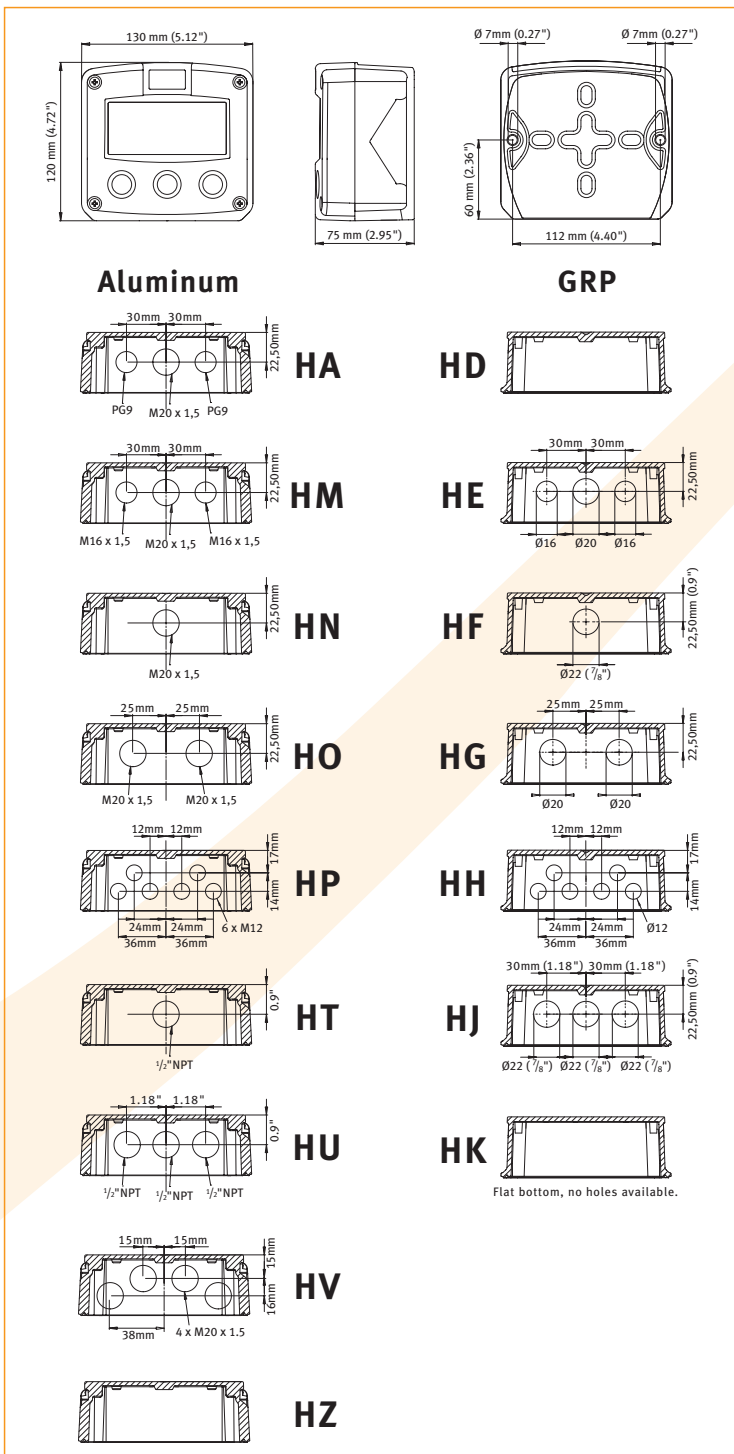

Terminal connections

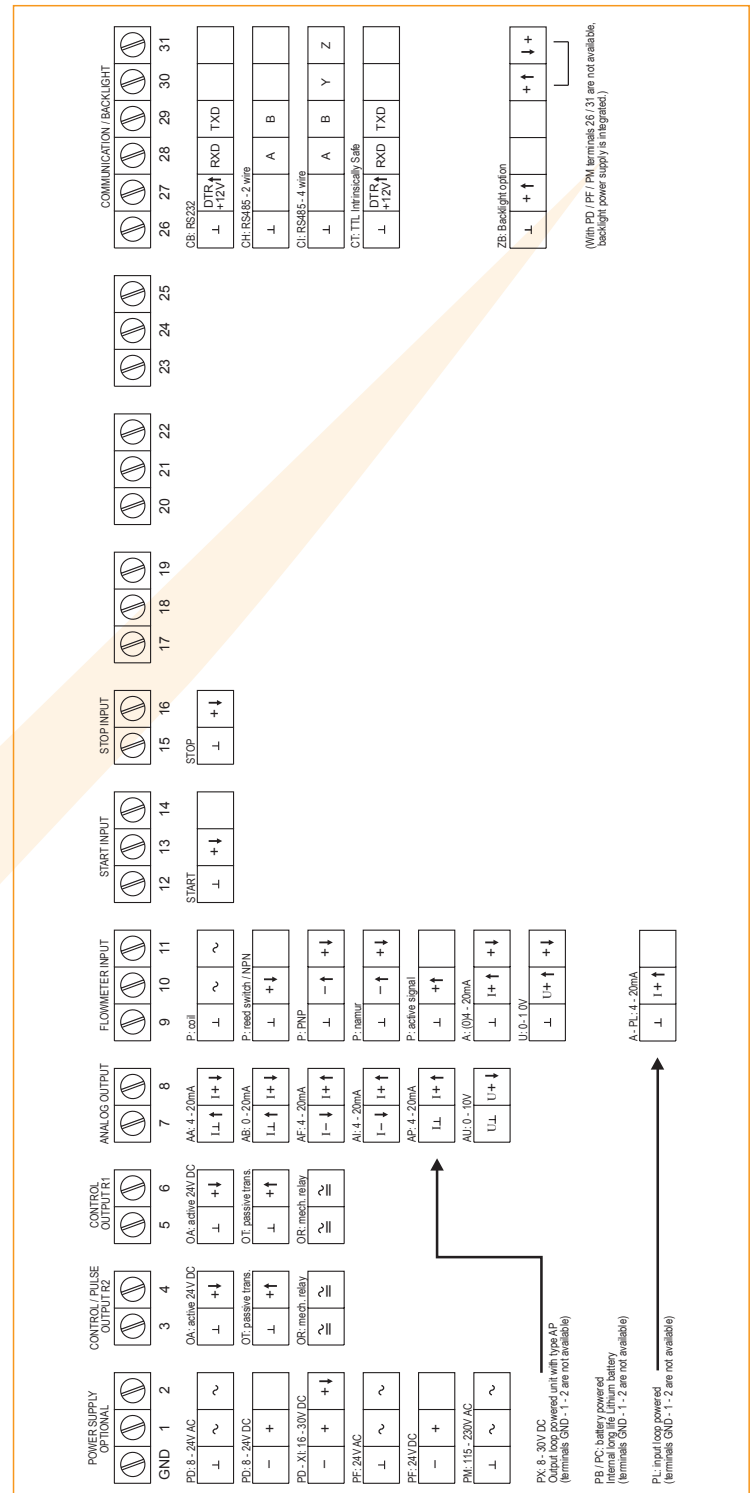

Display example - 90 x 40mm (3.5" x 1.6")

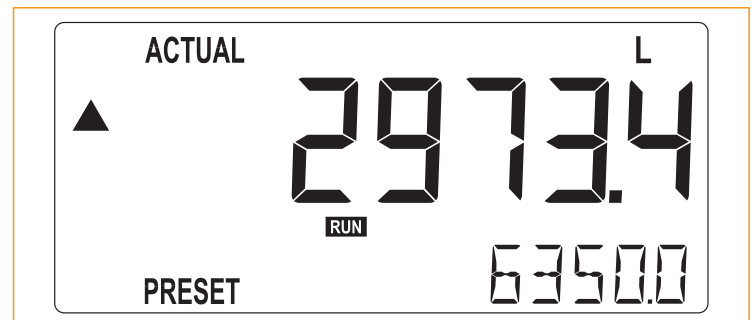

Typical wiring diagram F136-P-AP-CH-OT-PX

Typical wiring diagram F136-A-AA-CB-OA-PD

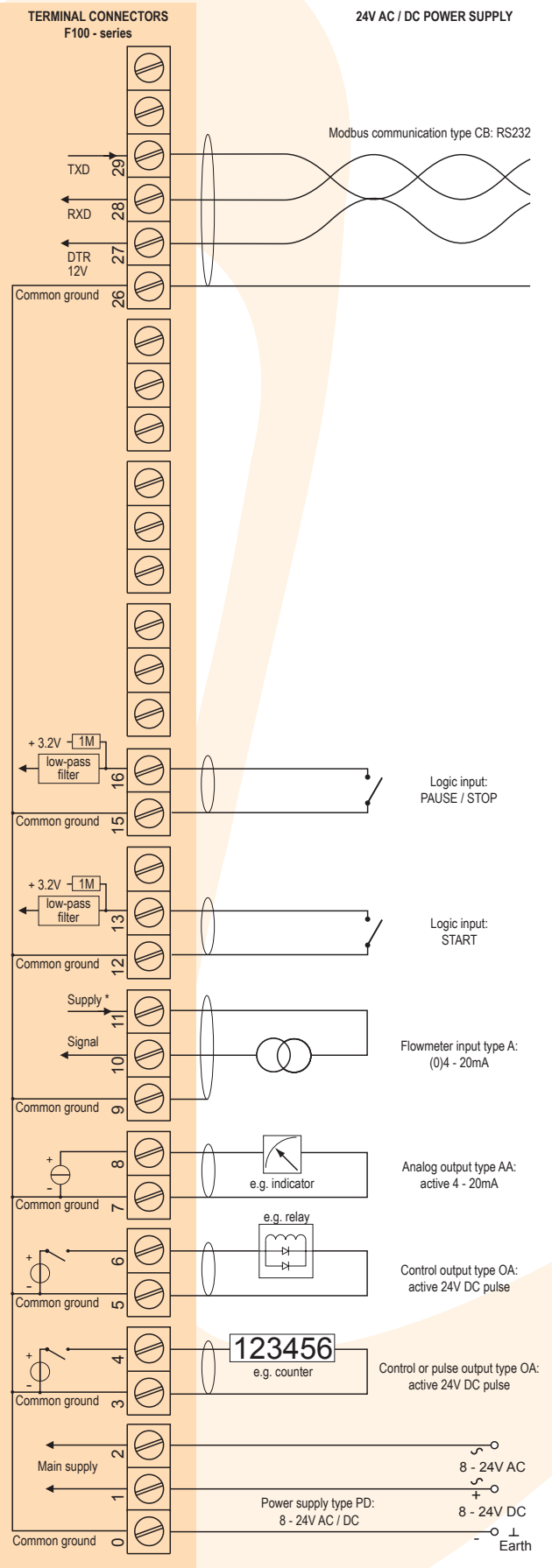
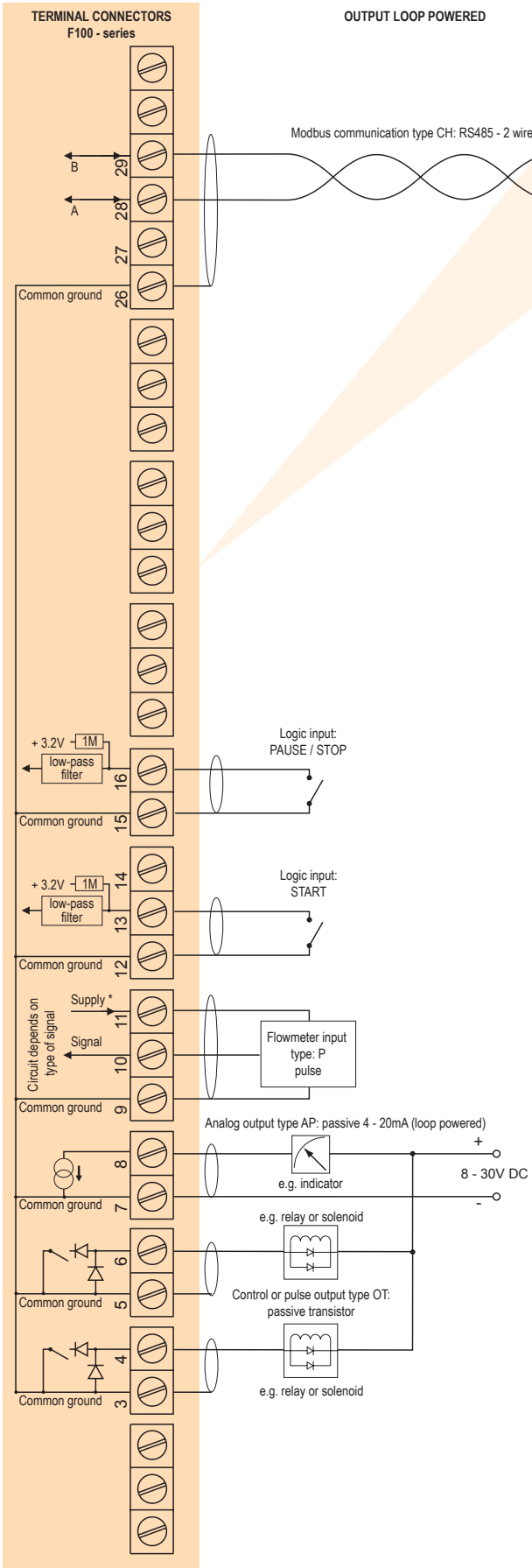

Hazardous area applications

The F136-XI has been certified according ATEX and IECEx by DEKRA for use in Intrinsically Safe applications with an ambient temperature of -40°C to +70°C (-40°F to +158°F).

- The ATEX markings for gas and dust applications are:

II 1 G Ex ia IIB/IIC T4 Ga
II 1 D Ex ia IIIC T100 □C Da IP6X.

- The IECEx markings for gas and dust applications are: **Ex ia IIC/IIB T4 Ga** and **Ex ia IIIC T100 □C Da IP6X.**

Besides the I.S. power supplies for the control outputs, it is allowed to connect up to three I.S. power supplies in IIB/IIC applications or one in IIC applications. Consult the certificate for the maximum input and output values of the circuits. Full functionality of the F136 remains available, including two stage control, 4 - 20mA output, pulse output and Modbus communication (type CT). Power supply type PD-XI offers a 8.2V sensor supply e.g. for one Namur sensor.

A flame proof enclosure with rating ATEX

Ex II 2 GD EEx d IIB T5 is available as well. Please contact your supplier for further details.

Certificate of conformity KEMA 03ATEX1074 X

• IECEx DEK 11.0042X

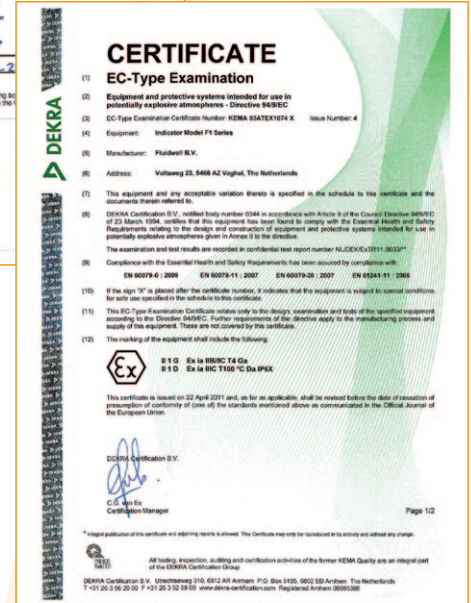

Configuration example IIB / IIIC and IIC - F136-P-AP-(CT)-OT-PX-XI - Output loop powered unit

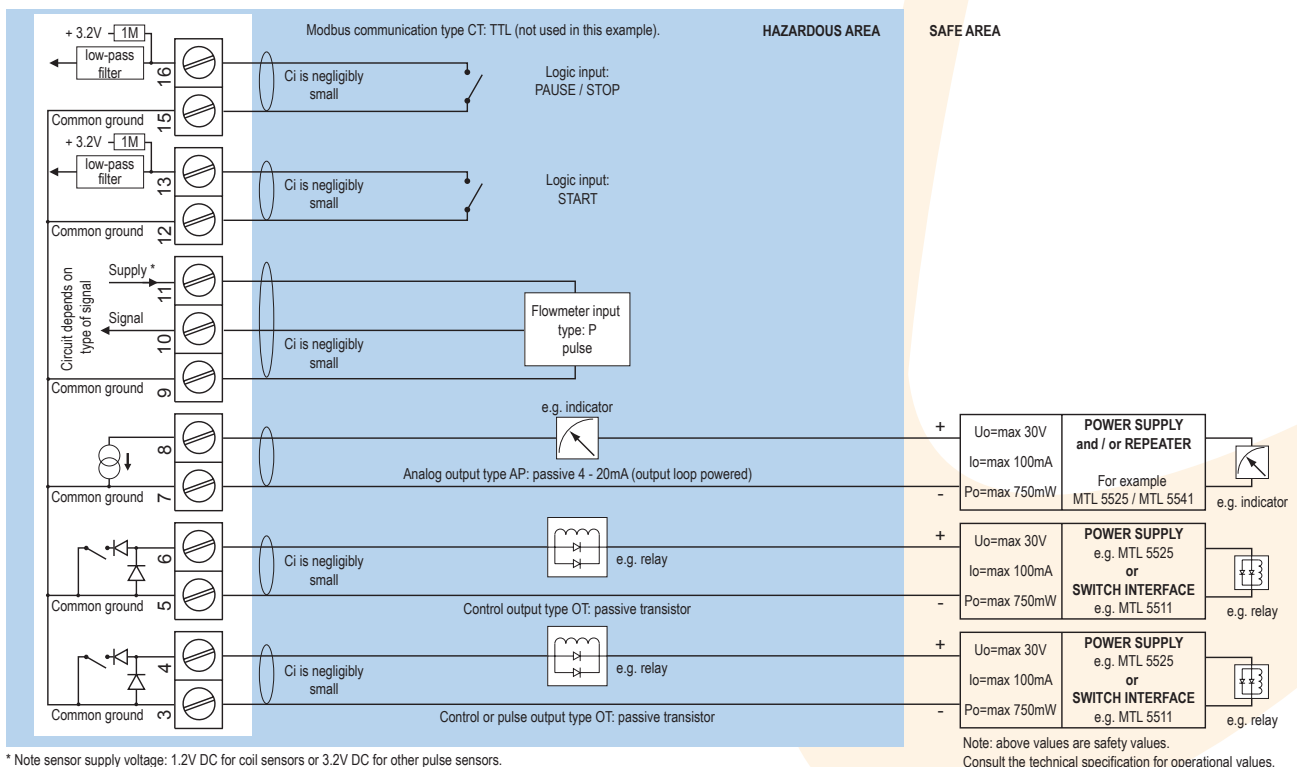

Configuration example IIB / IIIC - F136-A-AF-CT-OT-(PC)-(PD)-XI - Power supply 16 - 30V DC or battery powered

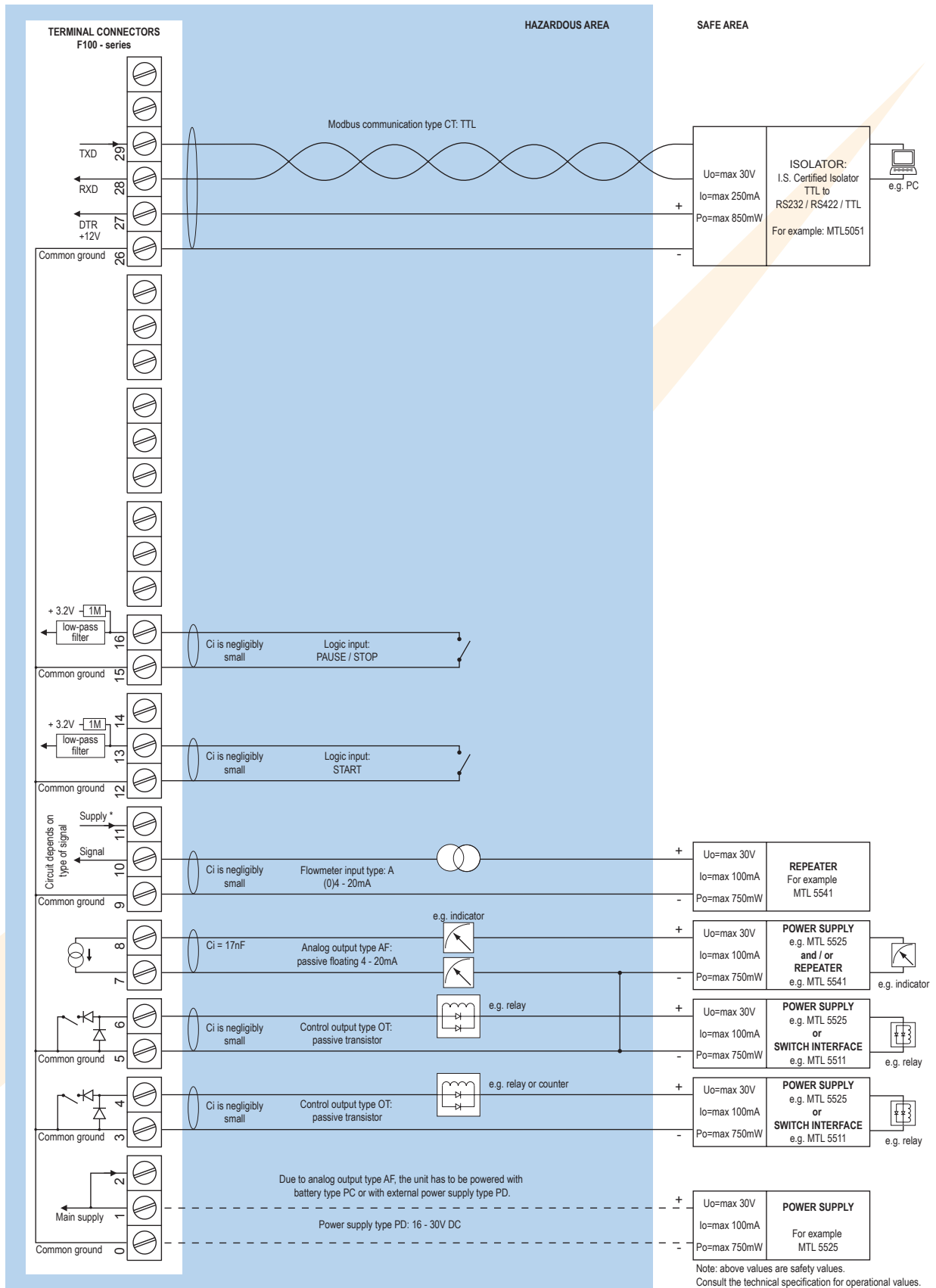

Profiles increasing output

Selectable profiles analog output signal:

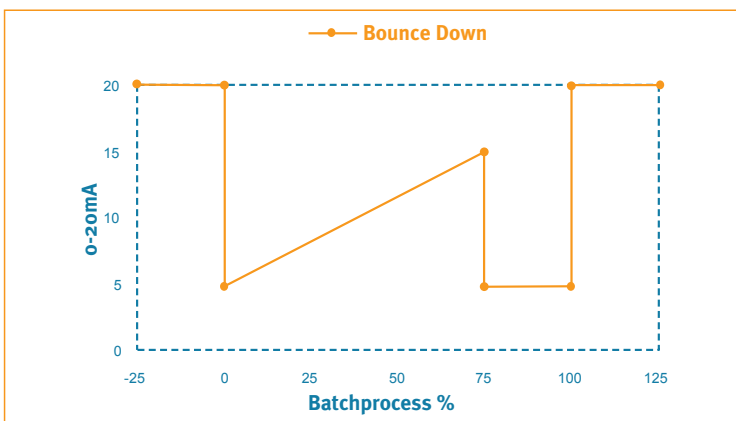
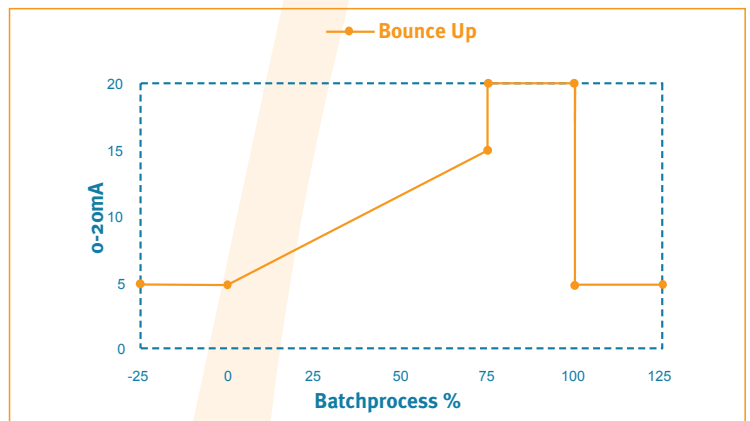
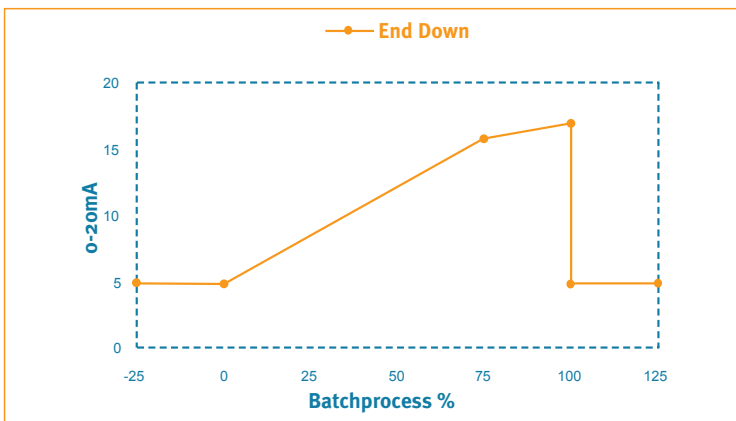
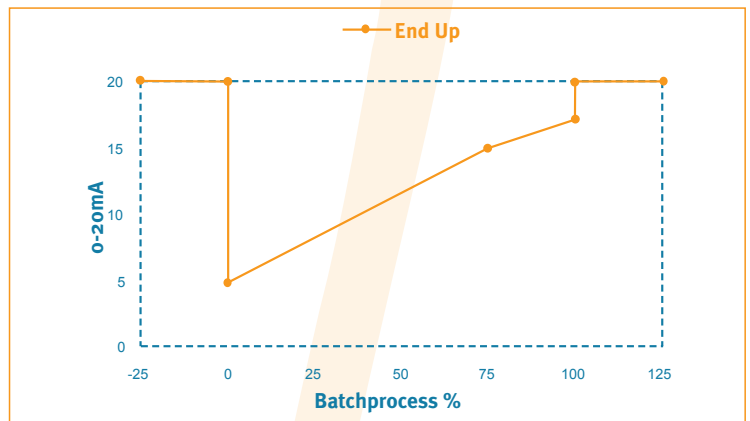
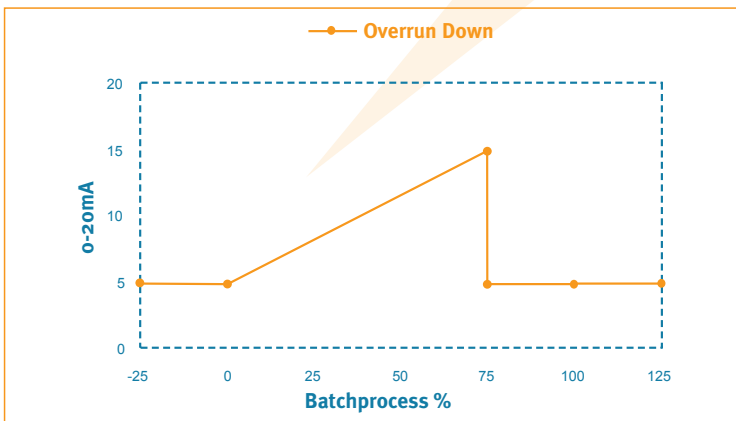
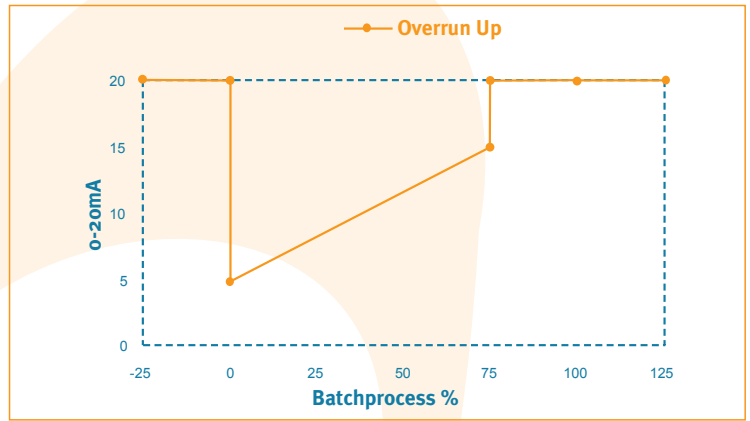
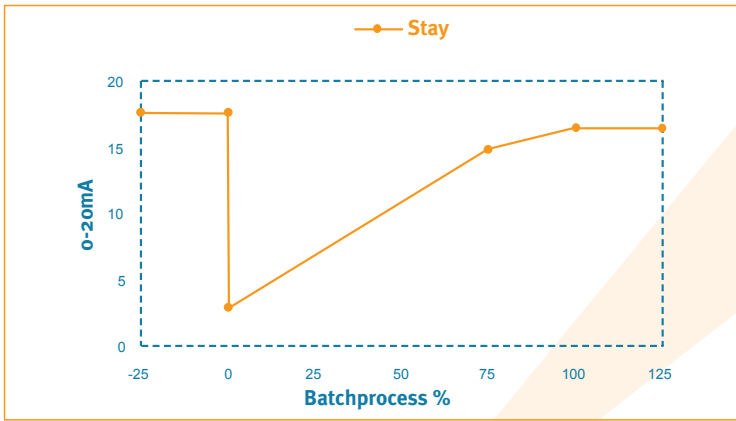

- 25%: Situation before a next batch start.
- 0%: The moment after START has been pressed.
- 75%: Valve will be closed due to the overrun correction.
- 100%: End of overrun-time which is end-of-batch.
- 125%: Situation after end-of-batch.

Profiles decreasing output

Selectable profiles analog output signal:

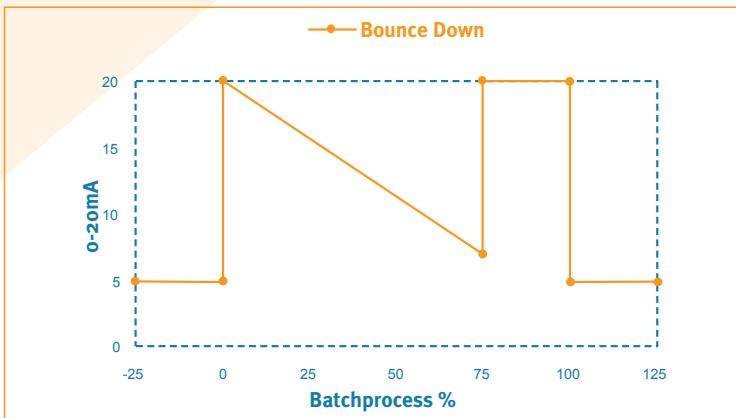
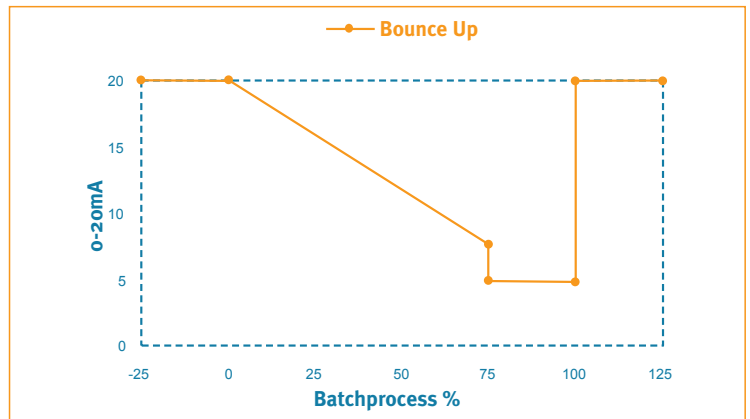
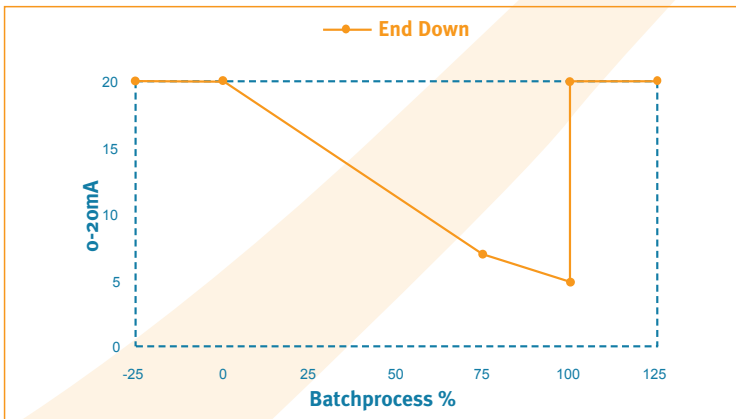
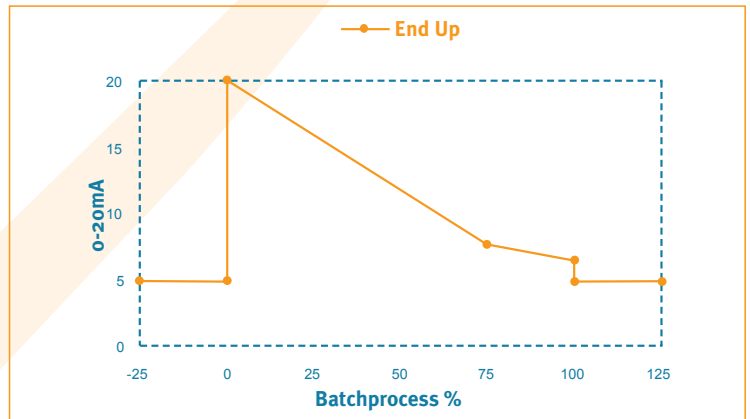
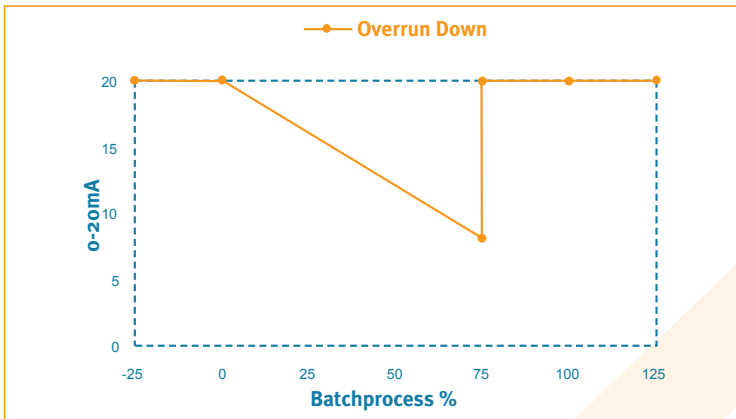
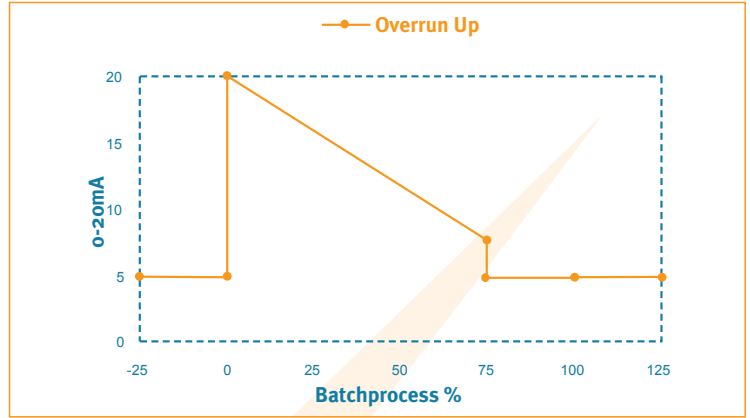
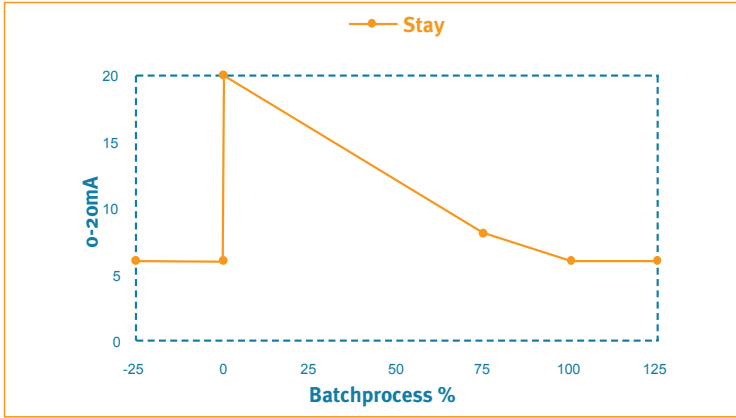

- 25%: Situation before a next batch start.
- 0%: The moment after START has been pressed.
- 75%: Valve will be closed due to the overrun correction.
- 100%: End of overrun-time which is end-of-batch.
- 125%: Situation after end-of-batch.

Technical specification

General

Display	
Type	High intensity reflective numeric and alphanumeric LCD, UV-resistant.
Dimensions	90 x 40mm (3.5" x 1.6").
Digits	Seven 17mm (0.67") and eleven 8mm (0.31") digits. Various symbols and measuring units.
Refresh rate	User definable: 8 times/sec. - 1 time/30 secs.
Option ZB	Transflective LCD with green LED backlight. Good readings in full sunlight and darkness.
Note ZB	Only available for safe area applications.

Operating temperature

Standard unit	-40°C to +80°C (-40°F to +176°F).
Intrinsically Safe	-40°C to +70°C (-40°F to +158°F).

Power requirements

Type PB	Long life Lithium battery - life-time depends upon settings and configuration - up to 5 years.
Type PC	Intrinsically Safe long life lithium battery - life-time depends upon settings and configuration - up to 5 years.
Type PD	8 - 24V AC / DC ± 10%. Power consumption max. 10 Watt. Intrinsically Safe: 16 - 30V DC; power consumption max. 0.75 Watt.
Type PF	24V AC / DC ± 10%. Power consumption max. 15 Watt.
Type PL	Input loop powered from sensor signal 4 - 20mA (type "A") - requires types AI or AF and OT (not Xi).
Type PM	115 - 230V AC ± 10%. Power consumption max. 15 Watt.
Type PX	8 - 30V DC. Power consumption max. 0.5 Watt.
Type ZB	12 - 24V DC ± 10% or internally powered with type PD / PF / PM. Power consumption max. 1 Watt.
Note PB/PF/PM	Not available Intrinsically Safe.
Note PF/PM	The total consumption of the sensors and outputs may not exceed 400mA @ 24V.
Note	For Intrinsically Safe applications, consult the safety values in the certificate.

Sensor excitation

Type PB/PC/PX	3.2V DC for pulse signals and 1.2V DC for coil pick-up.
Note	This is not a real sensor supply. Only suitable for sensors with a very low power consumption like coils (sine wave) and reed-switches.
Type PD	1.2 / 3.2 / 8.2 / 12 / 24V DC - max. 50mA @ 24V DC.
Type PD-XI	1.2 / 3.2 / 8.2V DC - max. 7mA @ 8.2V DC and mains power supply voltage (as connected to terminal 1).
Note	In case PD-XI and signal A or U: the sensor supply voltage is according to the power supply voltage connected to terminal 1. Also terminal 2 offers the same voltage.
Type PF / PM	1.2 / 3.2 / 8.2 / 12 / 24V DC - max. 400mA @ 24V DC.

Terminal connections

Type	Removable plug-in terminal strip. Wire max. 1.5mm ² and 2.5mm ² .
------	---

Data protection

Type	EEPROM backup of all settings. Backup of running totals every minute. Data retention at least 10 years.
Pass-code	Configuration settings can be pass-code protected.

Casing

General

Window	Polycarbonate window.
Sealing	Silicone.
Control keys	Three industrial micro-switch keys. UV-resistant silicone keypad.

Aluminum wall / field mount enclosures

General	Die-cast aluminum wall/field mount enclosure IP67 / NEMA 4X with 2-component UV-resistant coating.
Dimensions	130 x 120 x 75mm (5.12" x 4.72" x 2.95") - W x H x D.
Weight	1100 gr.
Type HA	Cable entry: 2 x PG9 and 1 x M20.
Type HM	Cable entry: 2 x M16 and 1 x M20.
Type HN	Cable entry: 1 x M20.
Type HO	Cable entry: 2 x M20.
Type HP	Cable entry: 6 x M12.
Type HT	Cable entry: 1 x 1/2" NPT.
Type HU	Cable entry: 3 x 1/2" NPT.
Type HV	Cable entry: 4 x M20.
Type HZ	Cable entry: no holes.

GRP wall / field mount enclosures

General	GRP wall/field mount enclosure IP67 / NEMA 4X, UV-resistant and flame retardant.
Dimensions	130 x 120 x 75mm (5.12" x 4.72" x 2.95") - W x H x D.
Weight	600 gr.
Type HD	Cable entry: no holes.
Type HE	Cable entry: 2 x Ø 16mm and 1 x Ø 20mm.
Type HF	Cable entry: 1 x Ø 22mm (7/8").
Type HG	Cable entry: 2 x Ø 20mm.
Type HH	Cable entry: 6 x Ø 12mm.
Type HJ	Cable entry: 3 x Ø 22mm (7/8").
Type HK	Flat bottom, cable entry: no holes.

Panel mount enclosures



Dimensions	130 x 120 x 60mm (5.12" x 4.72" x 2.36") - W x H x D.
Panel cut-out	115 x 98mm (4.53" x 3.86") L x H.
Type HB	Die-cast aluminum panel mount enclosure IP65 / NEMA 4X.
Weight	600 gr.
Type HC	GRP panel mount enclosure IP65 / NEMA 4X, UV-resistant and flame retardant.
Weight	450 gr.

ABS wall / field mount enclosures

General	Silicone free ABS wall/field mount enclosure IP65 with EPDM and PE sealings. UV-resistant polyester keypad (old HD enclosure).
Dimensions	130 x 114 x 71mm (5.1" x 4.5" x 2.8") - W x H x D.
Weight	450 gr.
Type HS	Cable entry: no holes.

Hazardous area

Intrinsically Safe (Type XI)

ATEX certification	 II 1 G Ex ia IIB/IIC T4 Ga. II 1 D Ex ia IIIC T100 °C Da IP6X.
IECEX certification	 Ex ia IIC/IIB T4 Ga. Ex ia IIIC T100 °C Da IP6X.
Ambient Ta	-40°C to +70°C (-40°F to +158°F).

Explosion proof (Type XF)

ATEX certification	 II 2 GD EEx d IIB T5.
Dimensions	300 x 250 x 200mm (11.8" x 9.9" x 7.9") L x H x D.
Weight	Appr. 15kg.

Environment

Electromagnetic compatibility	Compliant ref: EN 61326 (1997), EN 61010-1 (1993).
-------------------------------	--

Signal inputs

Flowmeter

Type P	Coil / sine wave (minimum 20mVpp or 80mVpp - sensitivity selectable), NPN/PNP, open collector, reed-switch, Namur, active pulse signals 8 - 12 and 24V DC.
Frequency	Minimum 0Hz - maximum 7kHz for total and flow rate. Maximum frequency depends on signal type and internal low-pass filter. E.g. reed switch with low-pass filter: max. frequency 120Hz.
K-Factor	0.000010 - 9,999,999 with variable decimal position.
Low-pass filter	Available for all pulse signals.
Option ZF	coil sensitivity 10mVpp.
Type A	(0)4 - 20mA. Analog input signal can be scaled to any desired range within 0 - 20mA.
Type U	0 - 10V DC. Analog input signal can be scaled to any desired range within 0 - 10V DC.
Accuracy	Resolution: 14 bit. Error < 0.025mA / ± 0.125% FS. Low level cut-off programmable.
Span	0.000010 - 9,999,999 with variable decimal position.
Update time	Four times per second.
Voltage drop	Type A: 2.5V @ 20mA.
Load impedance	Type U: 3kΩ.
Relationship	Linear and square root calculation.
Note	For signal type A and U: external power to sensor is required; e.g. type PD.

Logic inputs

Function	Two terminal inputs to start, stop and reset the batch process.
Type	Internally pulled-up switch contact - NPN.
Duration	Minimum pulse duration 100msec.

Signal outputs

Communication option

Function	Reading display information, reading / writing all configuration settings.
Protocol	Modbus RTU.
Speed	1200 - 2400 - 4800 - 9600 baud.
Addressing	Maximum 255 addresses.
Type CB	RS232
Type CH	RS485 2-wire
Type CI	RS485 4-wire
Type CT	TTL Intrinsically Safe.

Analog output

Function	Transmitting process situation.
Accuracy	10 bit. Error < 0.05%. Analog output signal can be scaled to any desired range.
Update time	Ten times per second.
Type AA	Active 4 - 20mA output (requires PD, PF or PM).
Type AB	Active 0 - 20mA output (requires PD, PF or PM).
Type AF	Passive floating 4 - 20mA output for Intrinsically Safe applications (requires XI + PC or PD).
Type AI	Passive galvanically isolated 4 - 20mA output - also available for battery powered models (requires PB, PD, PF, PL or PM).
Type AP	Passive 4 - 20mA output - not isolated. Unit will be loop powered.
Type AU	Active 0 - 10V DC output (requires PD, PF or PM).

Control / pulse output

Function	User defined: batch process one or two stage control - scaled pulse output according the running batch or according accumulated total.
Frequency	Max. 64Hz. Pulse length user definable between 7.8 msec up to 2 seconds.
Type OA	Two active 24V DC transistor outputs (PNP); max. 50mA per output (requires PD, PF or PM).
Type OR	Two electro-mechanical relay outputs (N.O.) - isolated; max. switch power 230V AC - 0.5A per relay (requires PF or PM).
Type OT	Two passive transistor outputs (NPN) - not isolated. Max. 50V DC - 300mA per output.

Operational

Operator functions

Displayed functions	<ul style="list-style-type: none"> • Preset value - can be entered by the operator. • Batched quantity or remaining quantity. • Total and accumulated total. • Total can be reset to zero by pressing the STOP-key twice.
---------------------	---

Preset / total

Digits	7 digits.
Units	L, m ³ , GAL, USGAL, kg, lb, bbl, no unit.
Decimals	0 - 1 - 2 or 3.
Note	Total can be reset to zero.

Accumulated total

Digits	11 digits.
Units / decimals	According to selection for total.
Note	Can not be reset to zero.

Accessories

Mounting accessories

ACFo2	Stainless steel wall mounting kit.
ACFo5	Stainless steel pipe mounting kit (worm gear clamps not included).
ACFo6	Two stainless steel worm gear clamps Ø 44 - 56mm.
ACFo7	Two stainless steel worm gear clamps Ø 58 - 75mm.
ACFo8	Two stainless steel worm gear clamps Ø 77 - 95mm.
ACFo9	Two stainless steel worm gear clamps Ø 106 - 138mm.
ACF10	Customized Grevopal tagplates for ACFo2 and ACFo5, including stainless steel screws. Dimension: 95mm x 12.5mm (3.75" x 0.50").

Ordering information

Standard configuration: F136-P-AP-CX-EX-HC-IX-OT-PX-TX-XX-ZX.

Ordering information:	F136	-	-A	-C	-EX	-H	-IX	-O	-P	-TX	-X	-Z
Flowmeter input signal												
A	⊗	(0)4	- 20mA input.									
P	⊗	Pulse input: coil, npn, pnp, namur, reed-switch.										
U	⊗	0 - 10V DC input.										
Analog output signal												
AA		Active 4 - 20mA output - requires PD, PF or PM.										
AB		Active 0 - 20mA output - requires PD, PF or PM.										
AF	⊗	I.S. floating 4 - 20mA output - requires XI + PC or PD.										
AI		Isolated 4 - 20mA output - requires PB, PD, PF, PL or PM.										
AP	⊗	Passive 4 - 20mA output, loop powered unit.										
AU		Active 0 - 10V DC output - requires PD, PF or PM.										
Communication												
CB		Communication RS232 - Modbus RTU.										
CH		Communication RS485 - 2wire - Modbus RTU.										
CI		Communication RS485 - 4 wire - Modbus RTU.										
CT	⊗	Intrinsically Safe TTL - Modbus RTU.										
CX	⊗	No communication.										
Flow equations												
EX	⊗	No flow equations.										
Panel mount enclosures - IP65 / NEMA4X												
HB	⊗	Aluminum enclosure.										
HC	⊗	GRP enclosure.										
GRP field / wall mount enclosures - IP67 / NEMA4X												
HD	⊗	Cable entry: no holes.										
HE	⊗	Cable entry: 2 x Ø 16mm & 1 x Ø 20mm.										
HF	⊗	Cable entry: 1 x Ø 22mm (7/8").										
HG	⊗	Cable entry: 2 x Ø 20mm.										
HH	⊗	Cable entry: 6 x Ø 12mm.										
HJ	⊗	Cable entry: 3 x Ø 22mm (7/8").										
HK	⊗	Flat bottom, cable entry: no holes.										
Aluminum field / wall mount enclosures - IP67 / NEMA4X												
HA	⊗	Cable entry: 2 x PG9 + 1 x M20.										
HM	⊗	Cable entry: 2 x M16 + 1 x M20.										
HN	⊗	Cable entry: 1 x M20.										
HO	⊗	Cable entry: 2 x M20.										
HP	⊗	Cable entry: 6 x M12.										
HT	⊗	Cable entry: 1 x 1/2"NPT.										
HU	⊗	Cable entry: 3 x 1/2"NPT.										
HV	⊗	Cable entry: 4 x M20.										
HZ	⊗	Cable entry: no holes.										
ABS field / wall mount enclosures - IP65												
HS	⊗	Silicone free ABS field enclosure – Cable entry: no holes (old HD enclosure).										
Additional inputs												
IX	⊗	No additional input.										
Outputs												
OA		Two active transistor outputs - requires PD, PF or PM.										
OR		Two mechanical relay outputs - requires PF or PM.										
OT	⊗	Two passive transistor outputs - standard configuration.										
Power supply												
PB		Lithium battery powered.										
PC	⊗	Lithium battery powered - Intrinsically Safe.										
PD	⊗	8 - 24V AC/DC + sensor supply - with XI: 16 - 30V DC.										
PF		24V AC/DC + sensor supply.										
PL		Input loop powered from sensor signal type "A" - requires AI or AF and OT (not Xi).										
PM		115 - 230V AC + sensor supply.										
PX	⊗	Basic power supply 8 - 30V DC (no real sensor supply). Unit requires external loop AP.										
Temperature input signal												
TX	⊗	No temperature input signal.										
Hazardous area												
XI	⊗	Intrinsically Safe, according ATEX and IECEx.										
XF		EExd enclosure - 3 keys.										
XX		Safe area only.										
Other options												
ZB		Backlight.										
ZF	⊗	Coil input 10mVpp.										
ZX	⊗	No options.										

The bold marked text contains the standard configuration.

⊗ Available Intrinsically Safe.

Specifications are subject to change without notice.