

RATIO CONTROLLER

WITH ANALOG CONTROL OUTPUT
AND HIGH / LOW ALARMS



Features

- Controls the desired ratio between a main and an additive flow.
- Displays flow rate A and B, alarms, ratio setpoint and actual ratio in percentage.
- Large 17mm (0.67") digits.
- Safety mode input to place the controller in a safe predefined position.
- Analog output to control a valve.
- Two alarm values can be entered in %: low and high ratio alarm.
- Bumpless switching between 3 operation modes: Hand, Local and Ratio.
- Green LED-backlight.
- Very compact design for panel mount, wall mount or field mount applications.
- Operational temperature -40°C up to +80°C (-40°F up to 176°F).
- Intrinsically Safe - ATEX and IECEx approval for gas and dust applications.
- Explosion/flame proof Ex II 2 GD EEx d IIB T5.
- Full Modbus communication RS232/485/TTL.
- Loop or battery powered, 8 - 24V AC / DC or 115 - 230V AC power supply.

Signal output

- (0)4 - 20mA / 0 - 10V DC control output.
- Two alarm outputs for low and high ratio alarm.

Signal input

Flow

- Reed-switch.
- NAMUR.
- NPN/ PNP pulse.
- Sine wave (coil).
- Active pulse signals.
- (0)4 - 20mA.
- 0 - 10V DC.

Status

- Safety mode input.

Applications

- In-line blending can be significantly affected by its control operations. The F124 ratio controller will show a strong influence of maintaining a good and constant quality of products and saves money on the blending components.

General information

Introduction

The F124 has been designed to ensure that two flows are kept at the same ratio even if the flows are changing. The F124 is a key product of the Fluidwell Process Controller family and is the alternative to replace existing pneumatic controllers in local control loops.

Operational

There are three operation modes:

Hand: the control output can be manually changed, there is no loop connection.

Local: the setpoint can be set and/or changed, corresponding with the process value of flow B.

Ratio: (normal operation) set the desired ratio in %, the process value corresponds with flow B/A .

Display

The display has large 17mm segments which show flowrate A and B, desired ratio and actual ratio. On-screen engineering units are easily configured from a comprehensive selection.

Configuration

All configuration settings are accessed via a simple operator menu which can be passcode protected. Each setting is clearly indicated with an alphanumeric description, which avoids confusing abbreviations and baffling codes. Once familiar with one F-series product, you will be able to program all models in the series without a manual. All settings are safely stored in EEPROM memory in the event of sudden power loss.

Analog output signal

The valve of the additive flow is controlled via the (0)4 - 20mA or 0 - 10V DC output signal. The output signal is updated ten times per second. The output signal can be passive, active or isolated where the passive output type will loop power the F124 as well.

Signal input

The F124 accept most pulse and analog input signals for volumetric flow or mass flow. The input signal type can be selected by the user in the configuration menu without having to adjust any sensitive mechanical dip-switches or jumpers. The analog input versions are even available as 4 - 20mA input loop powered displays.

Alarm output

Two fixed alarm outputs are available to transmit the ratio alarm condition, 1 low and 1 high alarm output. The output signals can be a passive NPN, active PNP or an isolated electro-mechanical relay. If there is a no-flow the alarm output will be disabled.

Safety mode

The F124 has a safety mode that keeps on transmitting a pre-defined value as long as the contact is made. After releasing the contact, the former value and function will be reinstalled.

Communication

All process data and settings can be read and modified manually or through the Modbus communication link (RS232 / RS485).

Full Modbus functionality remains available for the Intrinsically Safe version (TTL).

Hazardous areas

This model has been ATEX and IECEx certified Intrinsically Safe for gas and dust applications, with an allowed operational temperature of -40°C to +70°C (-40°F to +158°F).

A flame proof enclosure with ATEX certification offers the rating Ex II 2 GD EEx d IIB T5.

Enclosures

All enclosures are ATEX and IECEx approved. As standard the F124 is supplied in an GRP panel mount enclosure, which can be converted to an IP67 / NEMA 4X GRP field mount enclosure by the addition of a back case. Most popular is our rugged aluminum field mount enclosure.

Overview application F124

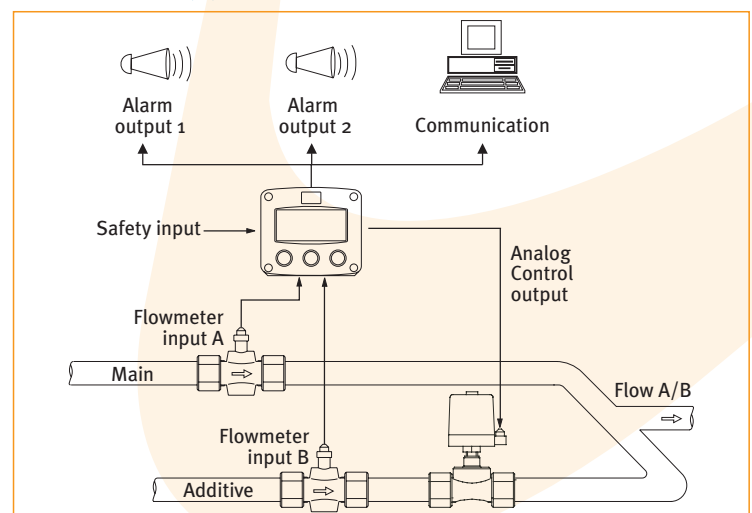

Dimensions enclosures Aluminum & GRP panel mount enclosure

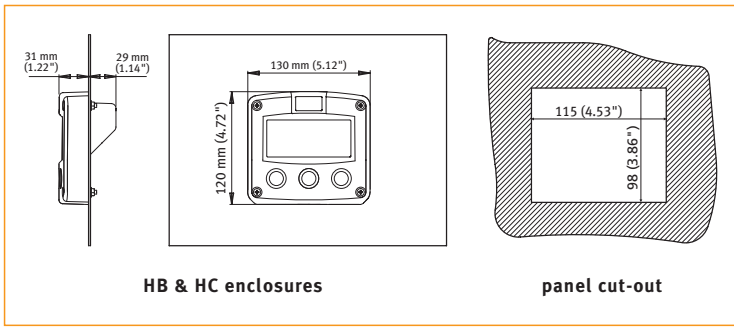

HB & HC enclosures

panel cut-out

Aluminum & GRP field / wall mount enclosures

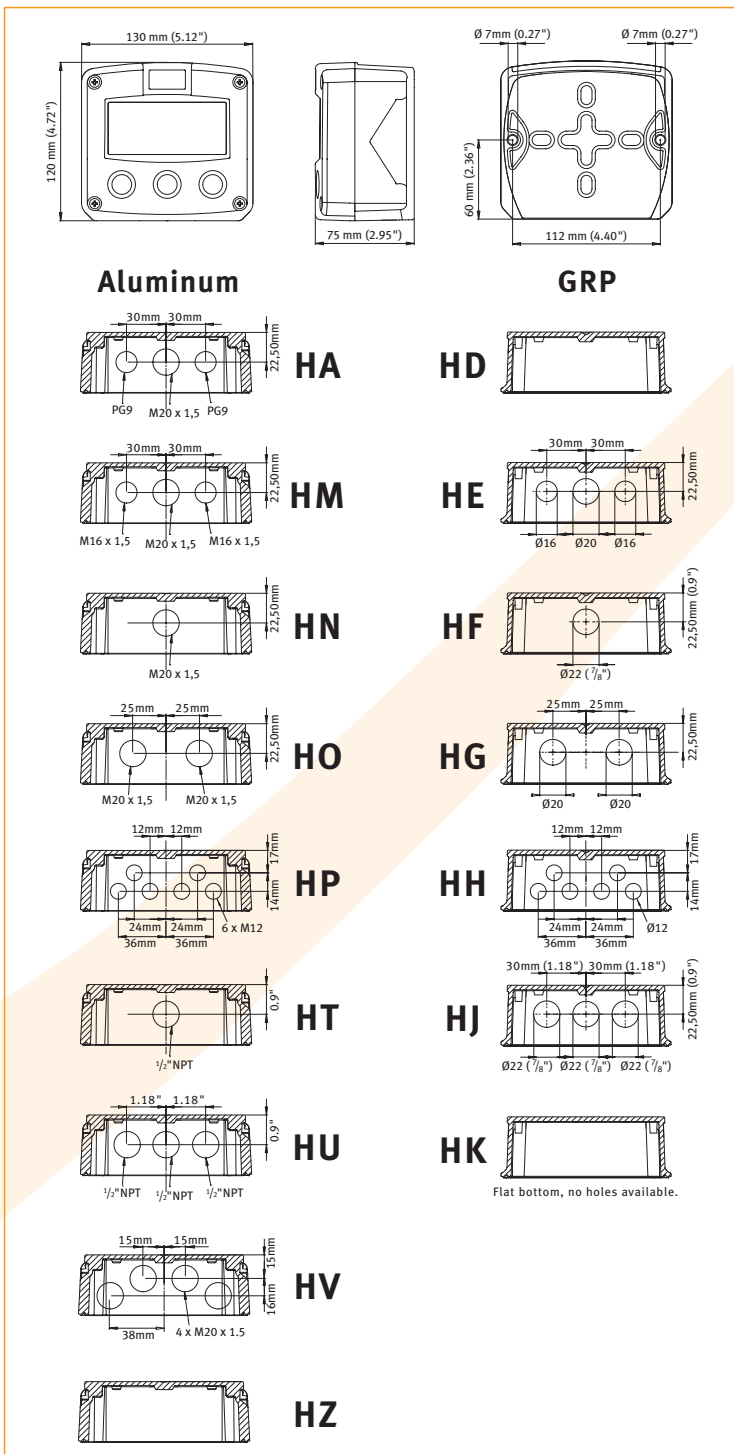

Terminal connections

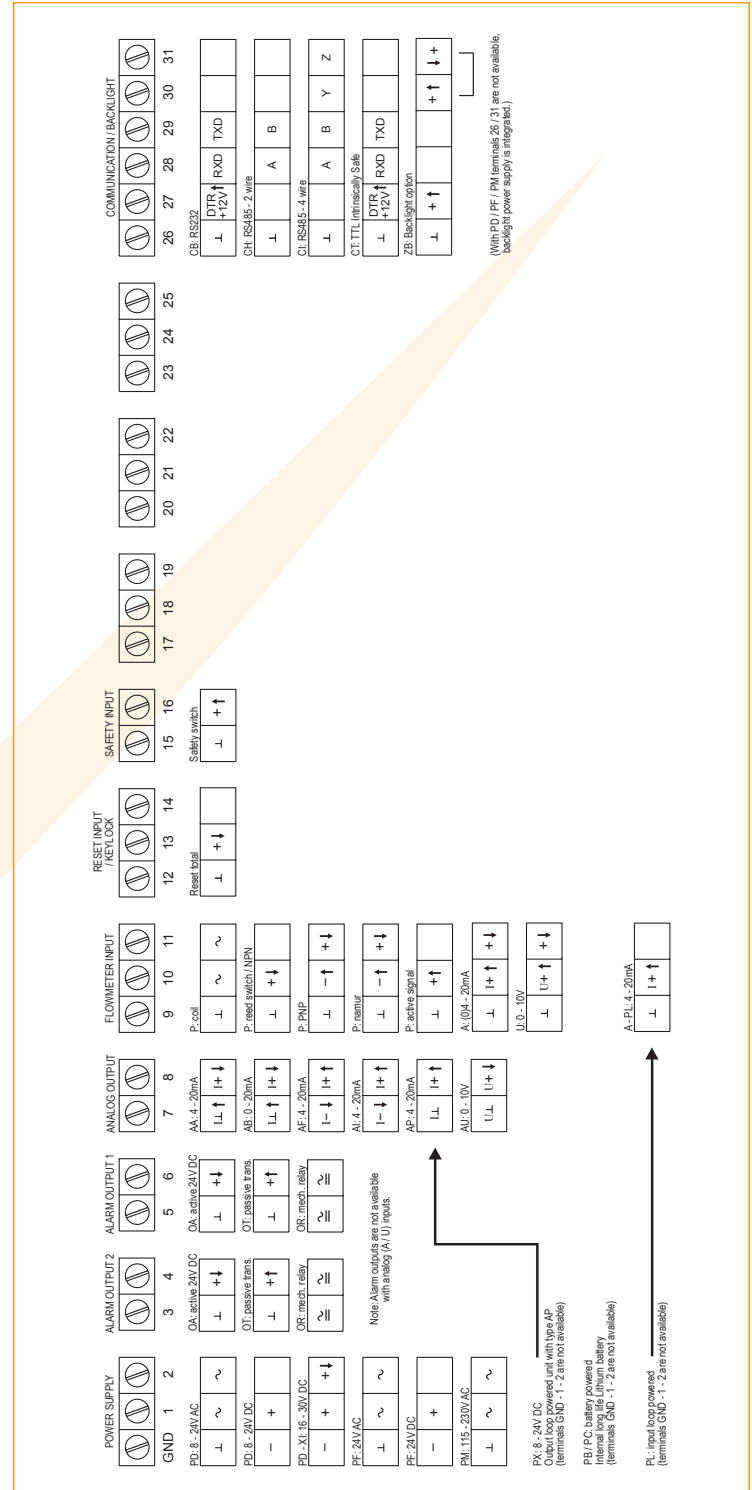

Display example - 90 x 40mm (3.5" x 1.6")



Typical wiring diagram F124-A-AP-CH-OT-PX

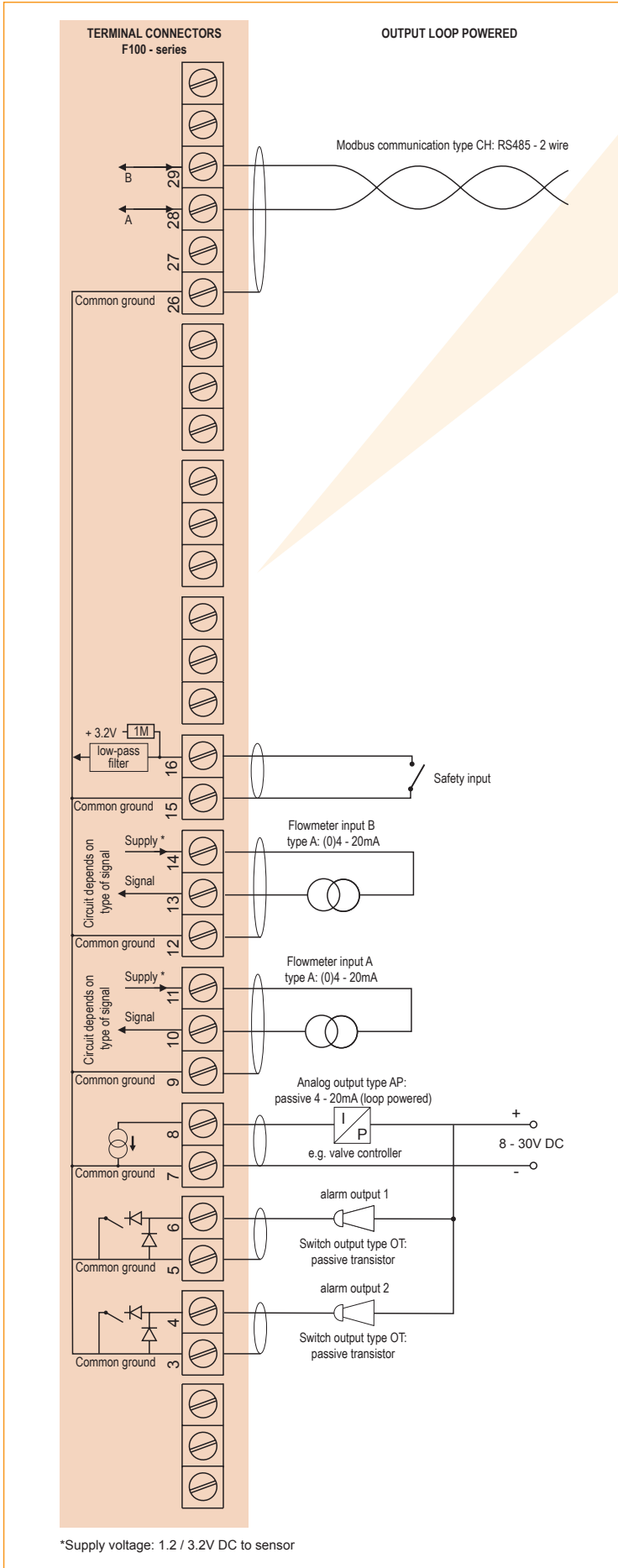

Typical wiring diagram F124-P-AP-CH-PF

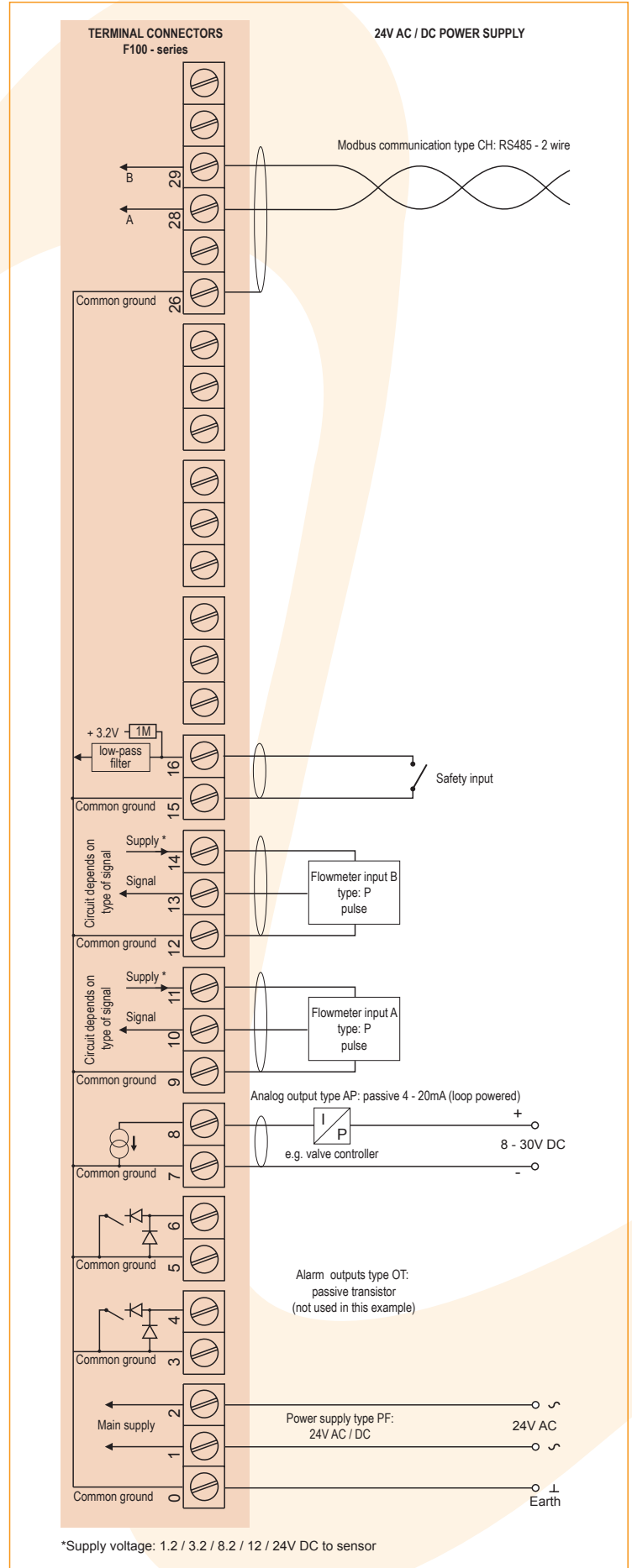

Typical wiring diagram F124-P-AA-CB-OA-PD

Typical wiring diagram F124-A-AI-CI-OR-PM

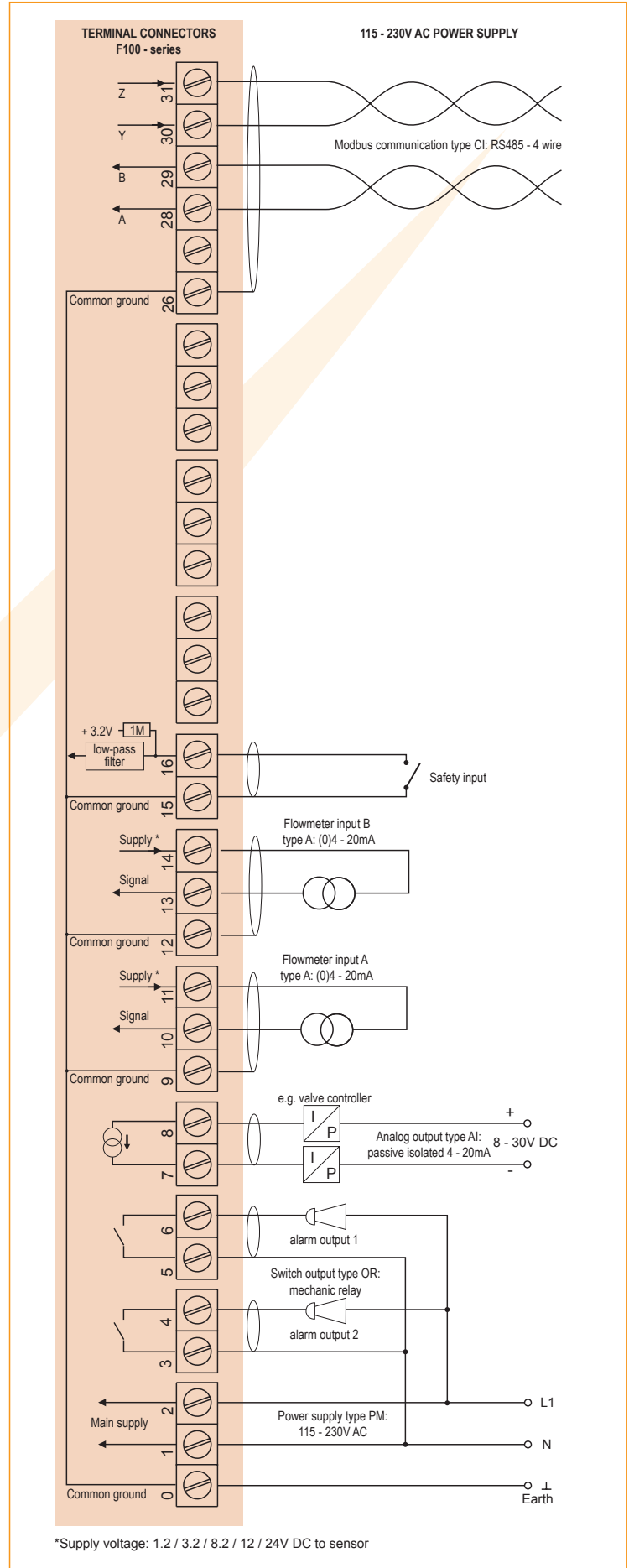
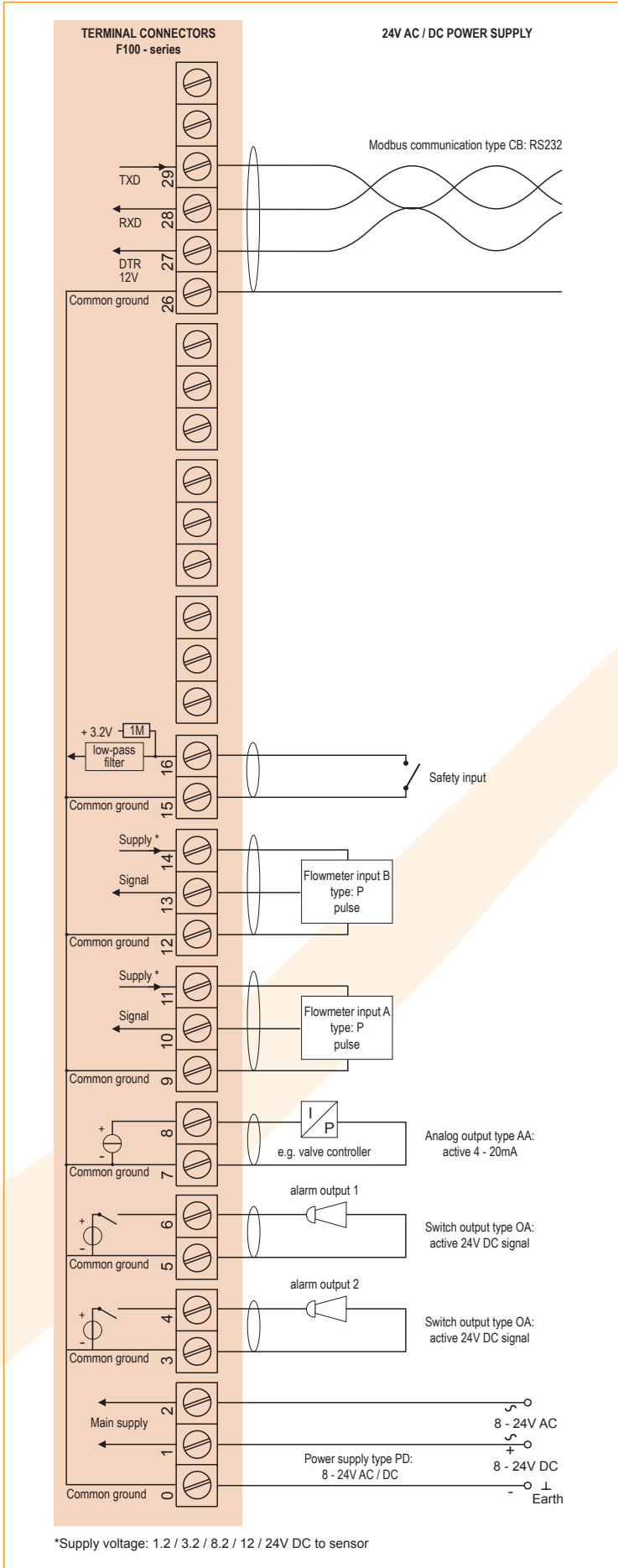

Hazardous area applications

The F124-XI has been certified according ATEX and IECEx by DEKRA for use in Intrinsically Safe applications with an ambient temperature of -40°C to +70°C (-40°F to +158°F).

- The ATEX markings for gas and dust applications are:

II 1 G Ex ia IIB/IIC T4 Ga
II 1 D Ex ia IIIC T100 □C Da IP6X.

- The IECEx markings for gas and dust applications are: **Ex ia IIC/IIB T4 Ga** and **Ex ia IIIC T100 □C Da IP6X.**

It is allowed to connect up to six barriers in IIB/IIIC applications or one barrier in IIC applications. Consult the certificate for the maximum input and output values of the circuits. Full functionality of the F124 remains available, including 8.2V sensor excitation for e.g. Namur sensors (type PD) and the Modbus communication type CT. A flame proof enclosure is available as well with rating ATEX **Ex II 2 GD EEx d IIB T5**. Please contact your supplier for further details.

Certificate of conformity KEMA 03ATEX1074 X

- IECEx DEK 11.0042X

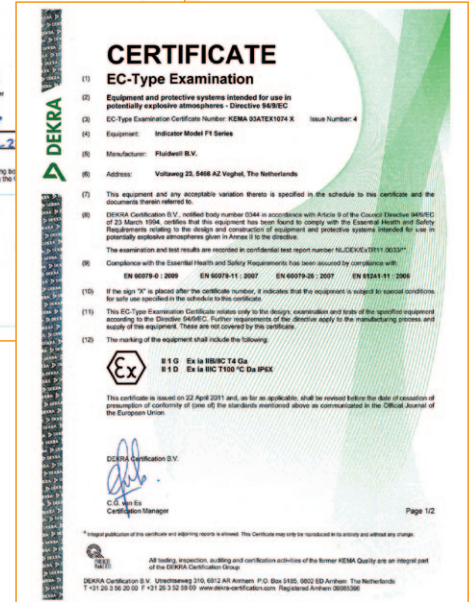

Configuration example IIB / IIIC and IIC - F124-P-AP-OT-PX-XI - Output loop powered unit

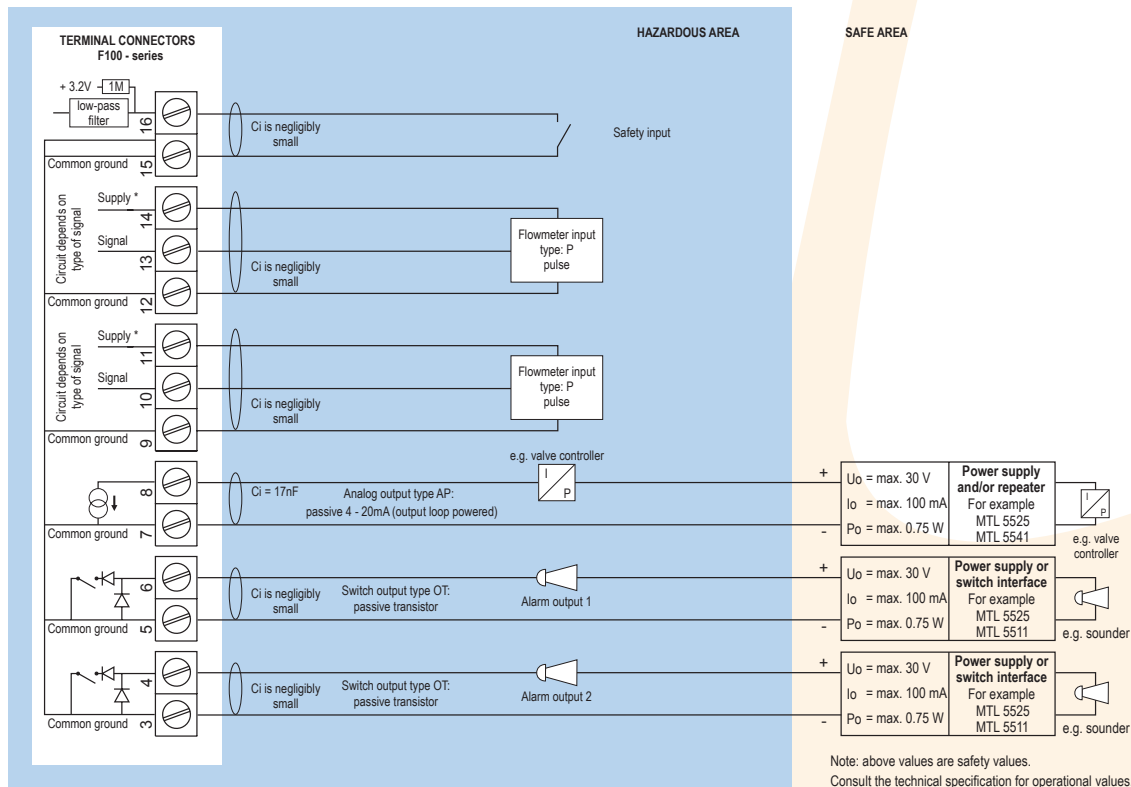

Configuration example IIB / IIIC - F124-A-AP-CT-OT-PX-XI - Output loop powered unit

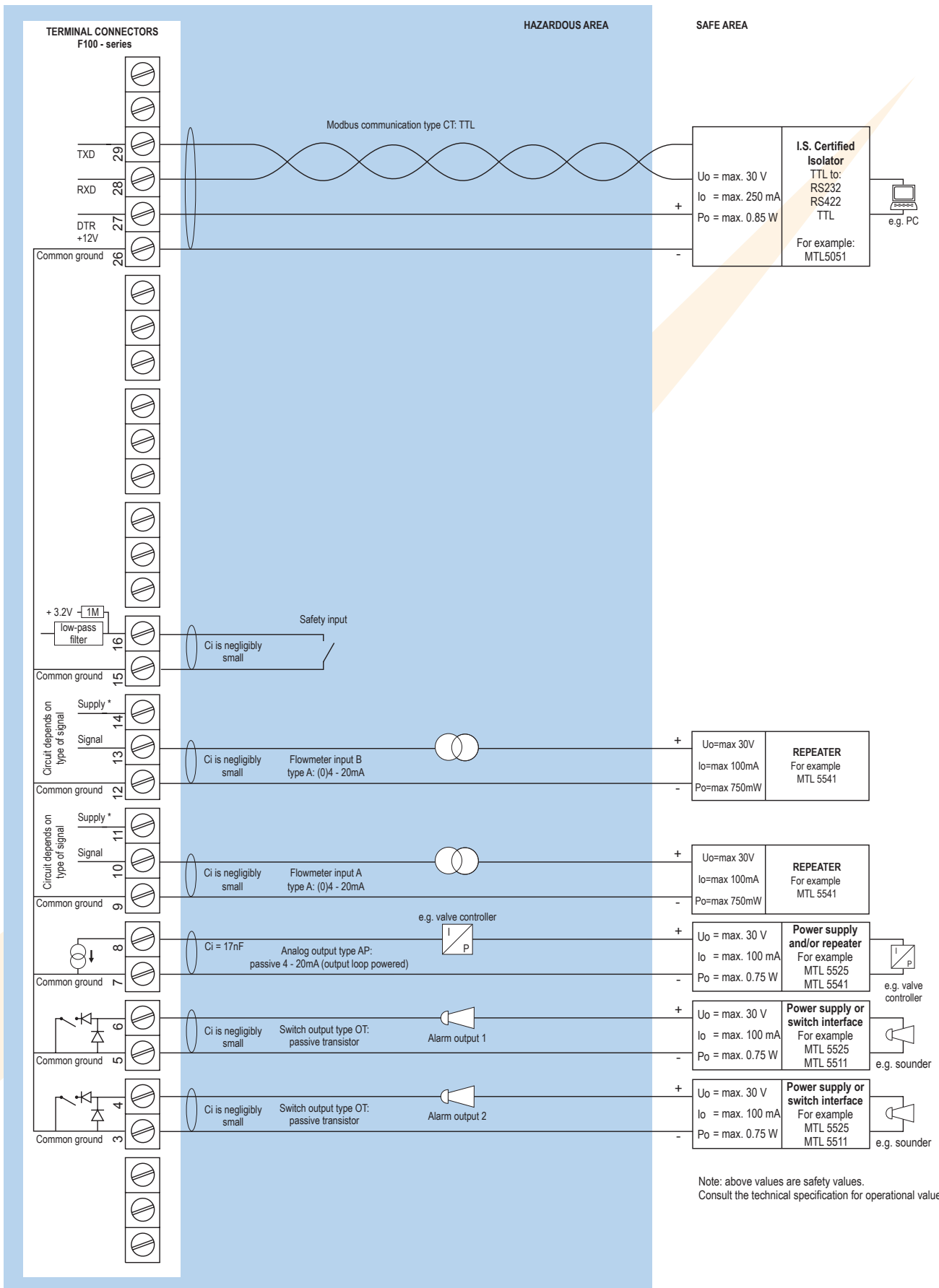

Configuration example IIB / IIIC and IIC - F124-A-AP-CT-OT-PD-XI - Power supply 16 - 30V DC

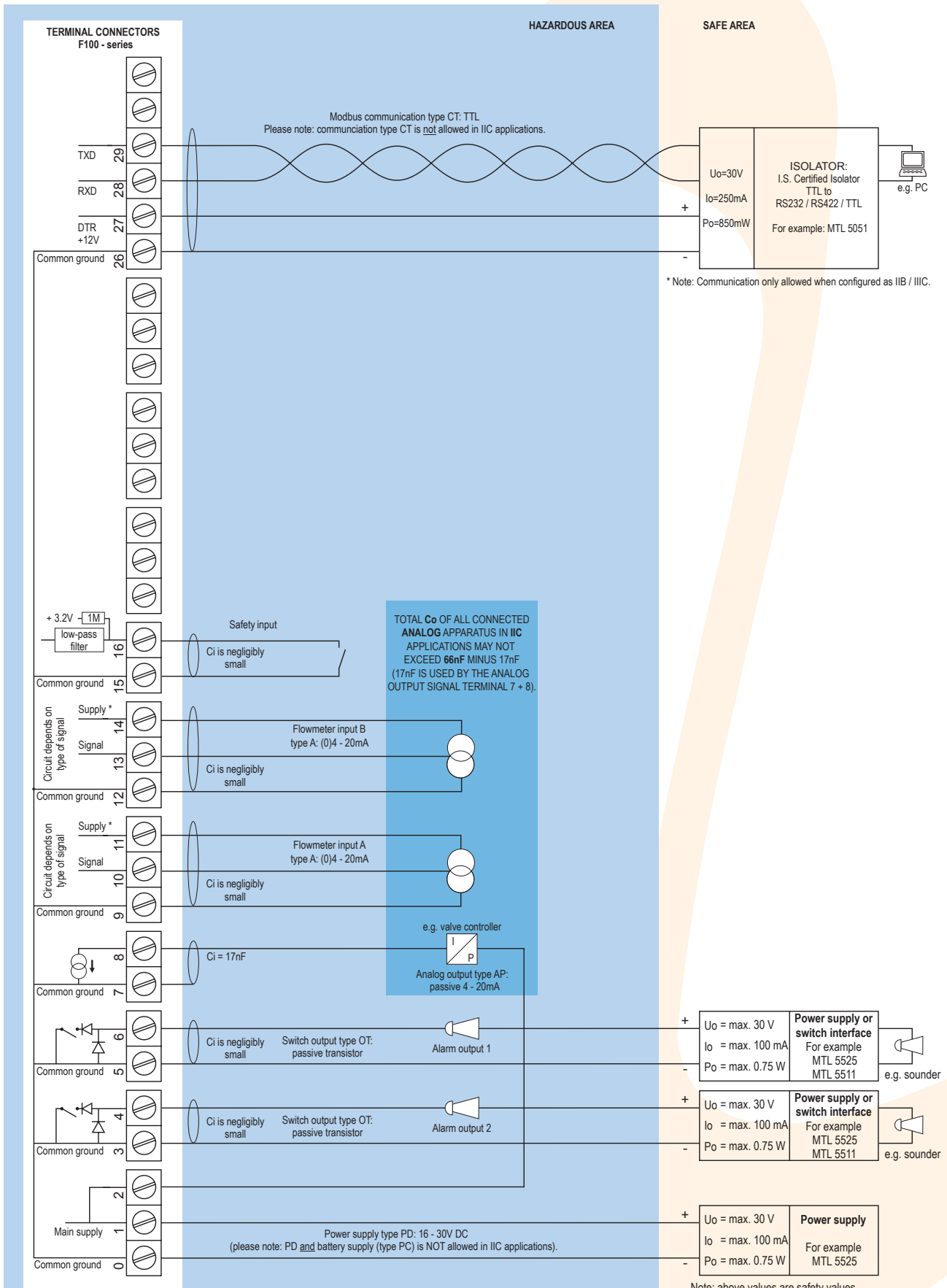

* Note power supply type PD: the supply voltage to pulse sensors is maximum 8.7V (U_o=max 8.7V I_o=max 25mA P_o=max 150mW) and to analog sensors as connected to terminal 1 (internally linked).

Configuration example IIB / IIIC - F124-P-AF-CT-OT-PD-XI - Power supply 16 - 30V DC

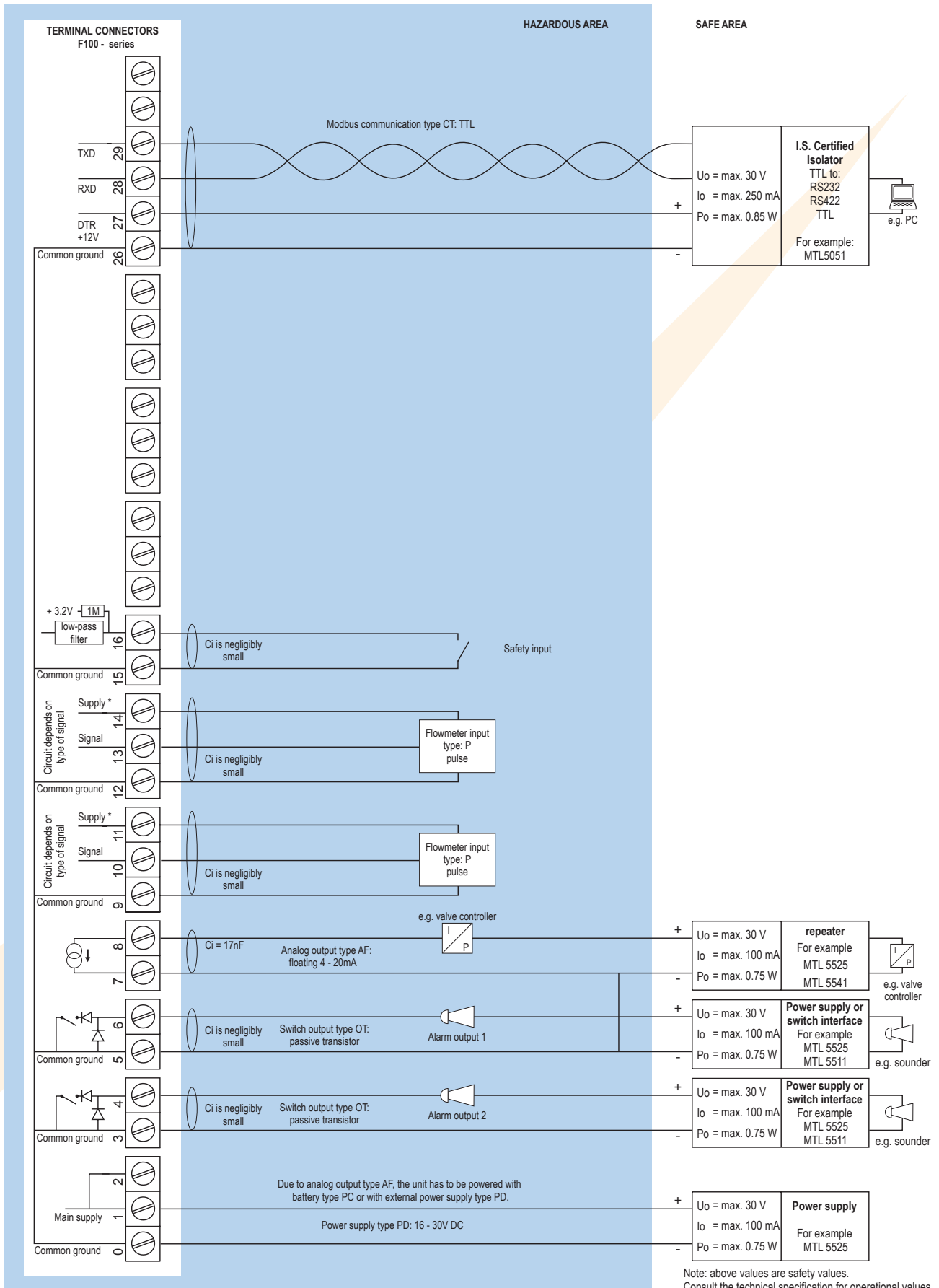

Technical specification

General

Display	
Type	High intensity reflective numeric and alphanumeric LCD, UV-resistant.
Dimensions	90 x 40mm (3.5" x 1.6").
Digits	Seven 17mm (0.67") and eleven 8mm (0.31") digits. Various symbols and measuring units.
Refresh rate	User definable: 8 times/sec. - 1 time/30 secs.
Option ZB	Transflective LCD with green LED backlight. Good readings in full sunlight and darkness.
Note ZB	Only available for safe area applications.

Operating temperature

Standard unit	-40°C to +80°C (-40°F to +176°F).
Intrinsically Safe	-40°C to +70°C (-40°F to +158°F).

Power requirements

Type PB	Long life Lithium battery - life-time depends upon settings and configuration - up to 5 years.
Type PC	Intrinsically Safe long life lithium battery - life-time depends upon settings and configuration - up to 5 years.
Type PD	8 - 24V AC / DC \pm 10%. Power consumption max. 10 Watt. Intrinsically Safe: 16 - 30V DC; power consumption max. 0.75 Watt.
Type PF	24V AC / DC \pm 10%. Power consumption max. 15 Watt.
Type PL	Input loop powered from sensor signal 4 - 20mA (type "A") - requires types AI or AF and OT (not Xi).
Type PM	115 - 230V AC \pm 10%. Power consumption max. 15 Watt.
Type PX	8 - 30V DC. Power consumption max. 0.5 Watt.
Type ZB	12 - 24V DC \pm 10% or internally powered with type PD / PF / PM. Power consumption max. 1 Watt.
Note PB/PF/PM	Not available Intrinsically Safe.
Note PF/PM	The total consumption of the sensors and outputs may not exceed 400mA @ 24V.
Note	For Intrinsically Safe applications, consult the safety values in the certificate.

Sensor excitation

Type PB/PC/PX	3.2V DC for pulse signals and 1.2V DC for coil pick-up.
Note	This is not a real sensor supply. Only suitable for sensors with a very low power consumption like coils (sine wave) and reed-switches.
Type PD	1.2 / 3.2 / 8.2 / 12 / 24V DC - max. 50mA @ 24V DC.
Type PD-XI	1.2 / 3.2 / 8.2V DC - max. 7mA @ 8.2V DC and mains power supply voltage (as connected to terminal 1).
Note	In case PD-XI and signal A or U: the sensor supply voltage is according to the power supply voltage connected to terminal 1. Also terminal 2 offers the same voltage.
Type PF / PM	1.2 / 3.2 / 8.2 / 12 / 24V DC - max. 400mA @ 24V DC.

Terminal connections

Type	Removable plug-in terminal strip. Wire max. 1.5mm ² and 2.5mm ² .
------	---

Data protection

Type	EEPROM backup of all settings. Data retention at least 10 years.
Pass-code	Configuration settings can be pass-code protected.

Casing

General

Window	Polycarbonate window.
Sealing	Silicone.
Control keys	Three industrial micro-switch keys. UV-resistant silicone keypad.

Aluminum wall / field mount enclosures

General	Die-cast aluminum wall/field mount enclosure IP67 / NEMA 4X with 2-component UV-resistant coating.
Dimensions	130 x 120 x 75mm (5.12" x 4.72" x 2.95") - W x H x D.
Weight	1100 gr.
Type HA	Cable entry: 2 x PG9 and 1 x M20.
Type HM	Cable entry: 2 x M16 and 1 x M20.
Type HN	Cable entry: 1 x M20.
Type HO	Cable entry: 2 x M20.
Type HP	Cable entry: 6 x M12.
Type HT	Cable entry: 1 x 1/2" NPT.
Type HU	Cable entry: 3 x 1/2" NPT.
Type HV	Cable entry: 4 x M20.
Type HZ	Cable entry: no holes.

GRP wall / field mount enclosures

General	GRP wall/field mount enclosure IP67 / NEMA 4X, UV-resistant and flame retardant.
Dimensions	130 x 120 x 75mm (5.12" x 4.72" x 2.95") - W x H x D.
Weight	600 gr.
Type HD	Cable entry: no holes.
Type HE	Cable entry: 2 x \emptyset 16mm and 1 x \emptyset 20mm.
Type HF	Cable entry: 1 x \emptyset 22mm (7/8").
Type HG	Cable entry: 2 x \emptyset 20mm.
Type HH	Cable entry: 6 x \emptyset 12mm.
Type HJ	Cable entry: 3 x \emptyset 22mm (7/8").
Type HK	Flat bottom, cable entry: no holes.

Panel mount enclosures



Dimensions	130 x 120 x 60mm (5.12" x 4.72" x 2.36") - W x H x D.
Panel cut-out	115 x 98mm (4.53" x 3.86") L x H.
Type HB	Die-cast aluminum panel mount enclosure IP65 / NEMA 4X.
Weight	600 gr.
Type HC	GRP panel mount enclosure IP65 / NEMA 4X, UV-resistant and flame retardant.
Weight	450 gr.

ABS wall / field mount enclosures

General	Silicone free ABS wall/field mount enclosure IP65 with EPDM and PE sealings. UV-resistant polyester keypad (old HD enclosure).
Dimensions	130 x 114 x 71mm (5.1" x 4.5" x 2.8") - W x H x D.
Weight	450 gr.
Type HS	Cable entry: no holes.

Hazardous area

Intrinsically Safe (Type XI)

ATEX certification	 II 1 G Ex ia IIB/IIC T4 Ga. II 1 D Ex ia IIIC T100 °C Da IP6X.
IECEX certification	 Ex ia IIC/IIB T4 Ga. Ex ia IIIC T100 °C Da IP6X.
Ambient Ta	-40°C to +70°C (-40°F to +158°F).

Explosion proof (Type XF)

ATEX certification	 II 2 GD EEx d IIB T5.
Dimensions	300 x 250 x 200mm (11.8" x 9.9" x 7.9") L x H x D.
Weight	Appr. 15kg.

Environment

Electromagnetic compatibility	Compliant ref: EN 61326 (1997), EN 61010-1 (1993).
-------------------------------	--

Signal inputs

Flowmeter

Type P	Coil / sine wave (minimum 20mVpp or 80mVpp - sensitivity selectable), NPN/PNP, open collector, reed-switch, Namur, active pulse signals 8 - 12 and 24V DC.
Frequency	Minimum 0Hz - maximum 7kHz for total and flow rate. Maximum frequency depends on signal type and internal low-pass filter. E.g. reed switch with low-pass filter: max. frequency 120Hz.
K-Factor	0.000010 - 9,999,999 with variable decimal position.
Low-pass filter	Available for all pulse signals.
Option ZF	coil sensitivity 10mVpp.
Type A	(0)4 - 20mA. Analog input signal can be scaled to any desired range within 0 - 20mA.
Type U	0 - 10V DC. Analog input signal can be scaled to any desired range within 0 - 10V DC.
Accuracy	Resolution: 14 bit. Error < 0.025mA / ± 0.125% FS. Low level cut-off programmable.
Span	0.000010 - 9,999,999 with variable decimal position.
Update time	Four times per second.
Voltage drop	Type A: 2.5V @ 20mA.
Load impedance	Type U: 3kΩ.
Relationship	Linear and square root calculation.
Note	For signal type A and U: external power to sensor is required; e.g. type PD.

External inputs

Function	Safety input.
Description	Terminal input to activate the predefined safety ratio. Internally pulled-up switch contact - NPN.
Duration	Minimum pulse duration 100msec.

Signal outputs

Communication option

Function	Reading display information, reading / writing all configuration settings.
Protocol	Modbus RTU.
Speed	1200 - 2400 - 4800 - 9600 baud.
Addressing	Maximum 255 addresses.
Type CB	RS232
Type CH	RS485 2-wire
Type CI	RS485 4-wire
Type CT	TTL Intrinsically Safe.

Analog output

Function	Controlling the ratio between flow A and B.
Accuracy	10 bit. Error < 0.05%. Analog output signal can be scaled to any desired range.
Update time	Ten times per second.
Type AA	Active 4 - 20mA output (requires PD, PF or PM).
Type AB	Active 0 - 20mA output (requires PD, PF or PM).
Type AF	Passive floating 4 - 20mA output for Intrinsically Safe applications (requires XI + PC or PD).
Type AI	Passive galvanically isolated 4 - 20mA output - also available for battery powered models (requires PB, PD, PF, or PM).
Type AP	Passive 4 - 20mA output - not isolated. Unit will be loop powered.
Type AU	Active 0 - 10V DC output (requires PD, PF or PM).

Alarm / pulse output

Function	Low or high ratio alarm output. Alarm value limits: 0 - 100%.
Frequency	Max. 64Hz. Pulse length user definable between 7.8 msec up to 2 seconds.
Type OA	Two active 24V DC transistor outputs (PNP); max. 50mA per output (requires PD, PF or PM).
Type OR	Two electro-mechanical relay outputs isolated (N.O.) - max. switch power 230V AC - 0.5A (requires PF or PM).
Type OT	Two passive transistor outputs (NPN) - not isolated. Max. 50V DC - 300mA per output.

Operational

Operator functions

Displayed functions	<ul style="list-style-type: none"> Ratio setpoint in %. Actual ratio in %. Flowrate A Flowrate B Low ratio alarm value. High ratio alarm value. Operation modes: Hand, Local or Ratio. Safety mode.
---------------------	---

Flowrate

Digits	7 digits.
Units	mL, L, m³, Gallons, kg, Ton, lb, bl, cf, RND, ft³, scf, Nm³, NL, igal - no units.
Decimals	0 - 1 - 2 or 3.
Time units	/sec - /min - /hr - /day.

Control Parameters



Operation mode	Hand, Local, Ratio.
Control action	Direct / Reverse.
Proportional band	0.1 to 999,9%.
Integral time	0.1 to 6,000.0 s or OFF (0.0).
Safety output	-5.0 to 105.0% (0) = Run / (1) = Safety output.
Control output limiter	-5.0 to 105.0% for both high and low limits.

Ordering information



Standard configuration: F124-P-AP-CX-EX-HC-IX-OT-PX-TX-XX-ZX.

Ordering information: F124 _ -A _ -C _ -EX -H _ -IX -O _ -P _ -TX -X _ -Z _



Flowmeter input signal

- A  (0)4 - 20mA input.
- P  **Pulse input: coil, npn, pnp, namur, reed-switch.**
- U  0 - 10V DC input.

Analog output signal

- AA Active 4 - 20mA output - requires PD, PF or PM.
- AB Active 0 - 20mA output - requires PD, PF or PM.
- AF  I.S. floating 4 - 20mA output - requires XI + PC or PD.
- AI Isolated 4 - 20mA output - requires PB, PD, PF or PM.
- AP  **Passive 4 - 20mA output, loop powered unit.**
- AU Active 0 - 10V DC output - requires PD, PF or PM.



Communication

- CB Communication RS232 - Modbus RTU.
- CH Communication RS485 - 2-wire - Modbus RTU.
- CI Communication RS485 - 4-wire - Modbus RTU.
- CT  Intrinsically Safe TTL - Modbus RTU.
- CX  **No communication.**







Flow equations

- EX  **No flow equations.**









Panel mount enclosures - IP65 / NEMA4X

- HB  Aluminum enclosure.
- HC  **GRP enclosure.**

GRP field / wall mount enclosures - IP67 / NEMA4X

- HD  Cable entry: no holes.
- HE  Cable entry: 2 x Ø 16mm & 1 x Ø 20mm.
- HF  Cable entry: 1 x Ø 22mm (7/8").
- HG  Cable entry: 2 x Ø 20mm.
- HH  Cable entry: 6 x Ø 12mm.
- HJ  Cable entry: 3 x Ø 22mm (7/8").
- HK  Flat bottom, cable entry: no holes.

Aluminum field / wall mount enclosures - IP67 / NEMA4X

- HA  Cable entry: 2 x PG9 + 1 x M20.
- HM  Cable entry: 2 x M16 + 1 x M20.
- HN  Cable entry: 1 x M20.
- HO  Cable entry: 2 x M20.
- HP  Cable entry: 6 x M12.
- HT  Cable entry: 1 x 1/2" NPT.
- HU  Cable entry: 3 x 1/2" NPT.
- HV  Cable entry: 4 x M20.
- HZ  Cable entry: no holes.

ABS field / wall mount enclosures - IP65

- HS  Silicone free ABS field enclosure – Cable entry: no holes (old HD enclosure).



Additional inputs

- IX  **No additional input.**

Outputs

- OA Two active transistor outputs - requires PD, PF or PM.
- OR Two mechanical relay outputs - requires PF or PM.
- OT  **Two passive transistor outputs - standard configuration.**

Power supply

- PB Lithium battery powered.
- PC  Lithium battery powered - Intrinsically Safe.
- PD  8 - 24V AC/DC + sensor supply - with XI: 16 - 30V DC.
- PF 24V AC/DC + sensor supply.
- PL Input loop powered from sensor signal type "A" - requires AI or AF and OT (not Xi).
- PM 115 - 230V AC + sensor supply.
- PX  **Basic power supply 8 - 30V DC (no real sensor supply). Unit requires external loop AP.**



Temperature input signal

- TX  **No temperature input signal.**

Hazardous area

- XI  Intrinsically Safe, according ATEX and IECEx.
- XF EExd enclosure - 3 keys.
- XX **Safe area only.**

Other options

- ZB Backlight.
- ZF  Coil input 10mVpp.
- ZX  **No options.**

The bold marked text contains the standard configuration.

 Available Intrinsically Safe.

Specifications are subject to change without notice.