

GENERAL PURPOSE INDICATOR

LOOP POWERED WITH VERY LARGE DIGITS



Features

- Universal loop powered indicator.
- Very large 26mm (1") high digits.
- Displays the actual value, measuring unit and loop current.
- Selectable on-screen engineering units: %, PPM, meter, m, cm, mm, ft, sqft, ML, L, NL, M³, nM³, GAL, USGAL, IGAL, bbl, CUFT, mg, g, kg, ton, lb, psi, psig, mbar, bar, barg, °C, °F, K, P, RPM, K, KPA, pH, mV, /sec, /min, /hr, /day or no unit (others on request).
- Piegraph indication: ten segments.
- Number of digits: 5¹/₂.
- Green/amber LED backlight with adjustable intensity.
- Operational temperature -40°C to +80°C (-40°F to 176°F).
- Environmental protection to IP67 (NEMA4X).
- Intrinsically Safe - ATEX, IECEx, FM and CSA approval for gas and dust applications.

Signal input

- 4 - 20mA.

Power supply

- Loop powered.

Applications

- The F090 takes operating energy from an input current (2-wire 4 - 20mA) and reduces installation cost. It accepts a wide range of process instruments, including flow (linear or square root), level, pressure and temperature transmitters. All these process parameters can be displayed in their own engineering units. The F090 is, like other F-Series, optional available with Intrinsic Safety for hazardous area applications.

General information

Introduction

The F090 is a local indicator to display the actual process value, range and loop current. The measuring unit to be displayed is simply selected through an alpha-numerical configuration menu. No adhesive labels have to be put on the outside of the enclosure: a weather proof and user friendly solution! The configuration of Span, offset and number of decimals is done through software functions, without any sensitive dip-switches or trimmers. A wide selection of options further enhances the capabilities of this model, including Intrinsic Safety for hazardous area applications.

Display

The display has 5¹/₂ large 26mm (1") digits to show the main process information. At the bottom line, smaller 8mm (0.31") alphanumeric digits are available to display the measuring unit and additional messages in case of an alarm; range error e.g. With the piegraph, an actual range indication is offered in a single glance. If desired, additional information can be presented after pressing the select key, like the actual loop current and the 0% and 100% process value. As the F090 has been designed for field mounted applications, a smart display update function has been incorporated to achieve a readable display even at -40°C (-40°F).

Backlight

For those applications where readability during day and night might be an issue, a bi-color backlight is available. The background color can be set to green or amber and the intensity can be adjusted from the keyboard. The display is a transfective type, which means that a high contrast reading is guaranteed in full sunlight as well as during the night. This backlight option is also available Intrinsically Safe.

Configuration

All configuration settings are accessed via a simple operator menu which can be pass-code protected. Each setting is clearly indicated with an alphanumeric description, which avoids confusing abbreviations and baffling codes. Once familiar with one F-series product, you will be able to program all models in the series

without a manual. All settings are safely stored in EEPROM memory in the event of sudden power failure.

Signal input

The F090 does accept 4 - 20mA input signals only. The input signal type can be tuned and set by the user in the configuration menu without having to adjust any sensitive mechanical dip-switches, jumpers or trimmers.

Power supply

The F090 is designed to be a loop powered indicator, which means it takes its operating energy from an input current (2-wire 4 - 20mA).

Hazardous area

For hazardous area applications, this model has been ATEX, IECEx, FM and CSA certified Intrinsically Safe for gas and dust applications, with an allowed operational temperature of -40°C to +70°C (-40°F to +158°F).

Enclosures

Various types of enclosures can be selected, all ATEX, IECEx, FM and CSA approved. As standard the F090 is supplied in a rugged GRP panel mount enclosure, which can be converted to an IP67 / NEMA 4X GRP field mount enclosure by the addition of a back case. Most popular is our aluminum field mount enclosure with IP67 / NEMA 4X rating. Both European or U.S. cable gland entry threads are available.

Overview application F090

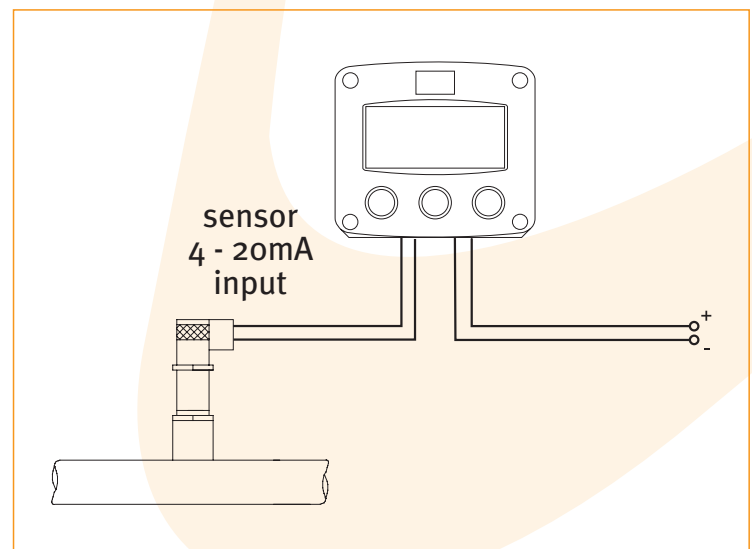

Dimensions enclosures Aluminum & GRP panel mount enclosure

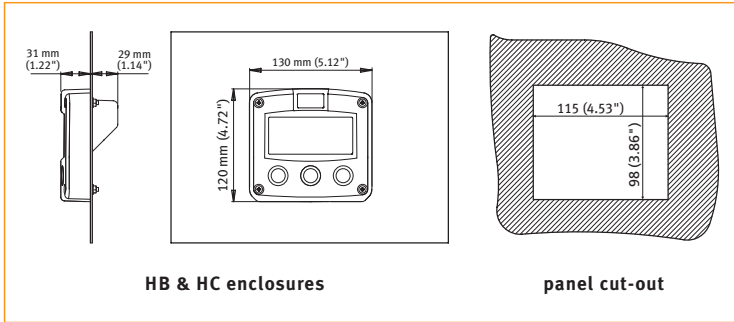

Aluminum & GRP field / wall mount enclosures

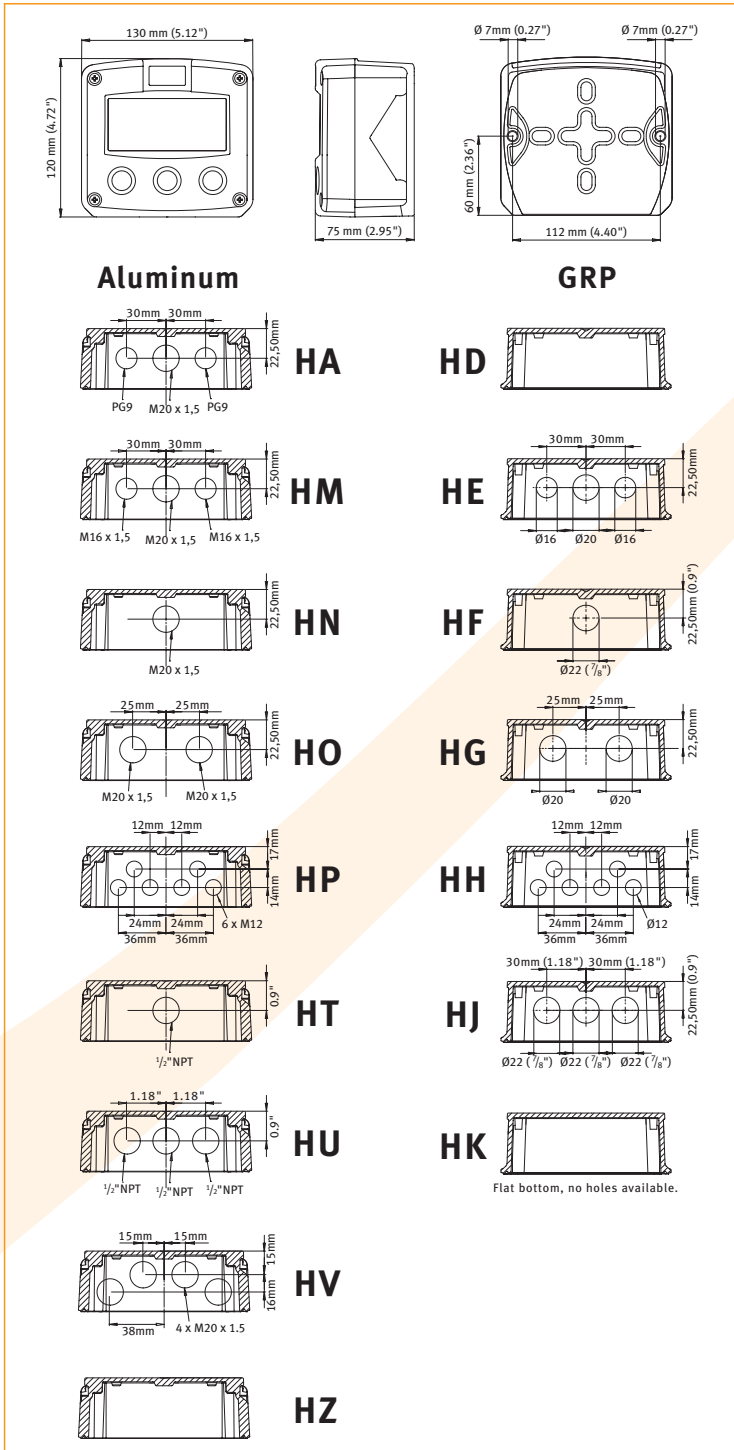

Terminal connections power supply type PL

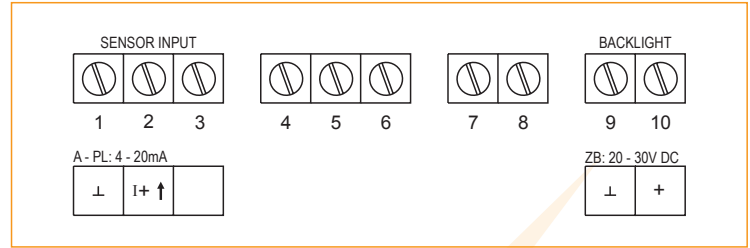

Display example - 90 x 40mm (3.5" x 1.6")

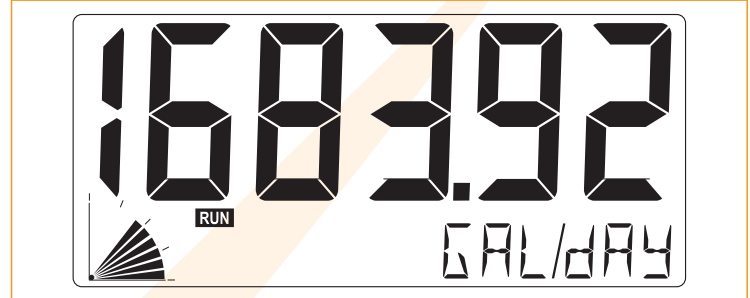

Accessories

Mounting accessories

- ACFo2 Stainless steel wall mounting kit.
- ACFo5 Stainless steel pipe mounting kit (worm gear clamps not included).
- ACFo6 Two stainless steel worm gear clamps \varnothing 44 - 56mm.
- ACFo7 Two stainless steel worm gear clamps \varnothing 58 - 75mm.
- ACFo8 Two stainless steel worm gear clamps \varnothing 77 - 95mm.
- ACFo9 Two stainless steel worm gear clamps \varnothing 106 - 138mm.
- ACFo10 Customized Grevopal tagplates for ACFo2 and ACFo5, including stainless steel screws.
Dimension: 95mm x 12.5mm (3.75" x 0.50").

Cable gland accessories

- ACF20 For HA enclosure, includes O-rings.
- ACF25 For HE enclosure, includes locknuts and O-rings.
- ACF26 For HF enclosure, includes locknuts and O-rings.
- ACF27 For HG enclosure, includes locknuts and O-rings.
- ACF28 For HH enclosure, includes locknuts and O-rings.
- ACF29 For HJ enclosure, includes locknuts and O-rings.
- ACF32 For HM enclosure, includes O-rings.
- ACF33 For HN enclosure, includes O-rings.
- ACF34 For HO enclosure, includes O-rings.
- ACF35 For HP enclosure, includes O-rings.
- ACF39 For HT enclosure, includes O-rings.
- ACF40 For HU enclosure, includes O-rings.

Blind plug accessories

- ACF50 For HA enclosure, includes O-rings.
- ACF55 For HE enclosure, includes locknuts and O-rings.
- ACF56 For HF enclosure, includes locknuts and O-rings.
- ACF57 For HG enclosure, includes locknuts and O-rings.
- ACF58 For HH enclosure, includes locknuts and O-rings.
- ACF59 For HJ enclosure, includes locknuts and O-rings.
- ACF62 For HM enclosure, includes O-rings.
- ACF63 For HN enclosure, includes O-rings.
- ACF64 For HO enclosure, includes O-rings.
- ACF65 For HP enclosure, includes O-rings.
- ACF69 For HT enclosure, includes O-rings.
- ACF70 For HU enclosure, includes O-rings.

Hazardous area applications

The F090-XI has been certified according ATEX and IECEx by KEMA and according CSA c-us and FM for use in Intrinsically Safe applications with an ambient temperature of -40°C to +70°C (-40°F to +158°F).

- The ATEX markings for gas and dust applications are:

Ex II 1 G Ex ia IIC T4
II 1 D Ex iaD 20 IP 65/67 T 100 [C].

- The IECEx markings for gas and dust applications are: **Ga Ex ia IIC T4** and **Ex iaD 20 IP 65/67 T100** [C].
- The CSA c-us markings are: **Class I/II/III, Division 1, Groups A, B, C, D, E, F, G, Temperature class T4 and Class I, Zone 0, AEx ia IIC T4.**
- The FM markings are: **Class I/II/III, Division 1, Groups A, B, C, D, E, F, G, Temperature class T4 and Class I, Zone 0, AEx ia IIC T4.**

It is allowed to connect up to two I.S. power supplies to power the unit and backlight. Consult the certificate for the maximum input and output values of the circuits.

Certificate of conformity KEMA 05ATEX1168 X

• IECEx KEM 08.0006X • CSA.08.2059461 X



Configuration example IIA - IIB and IIC - Fogo-A-PL-XI-ZB - Input loop powered

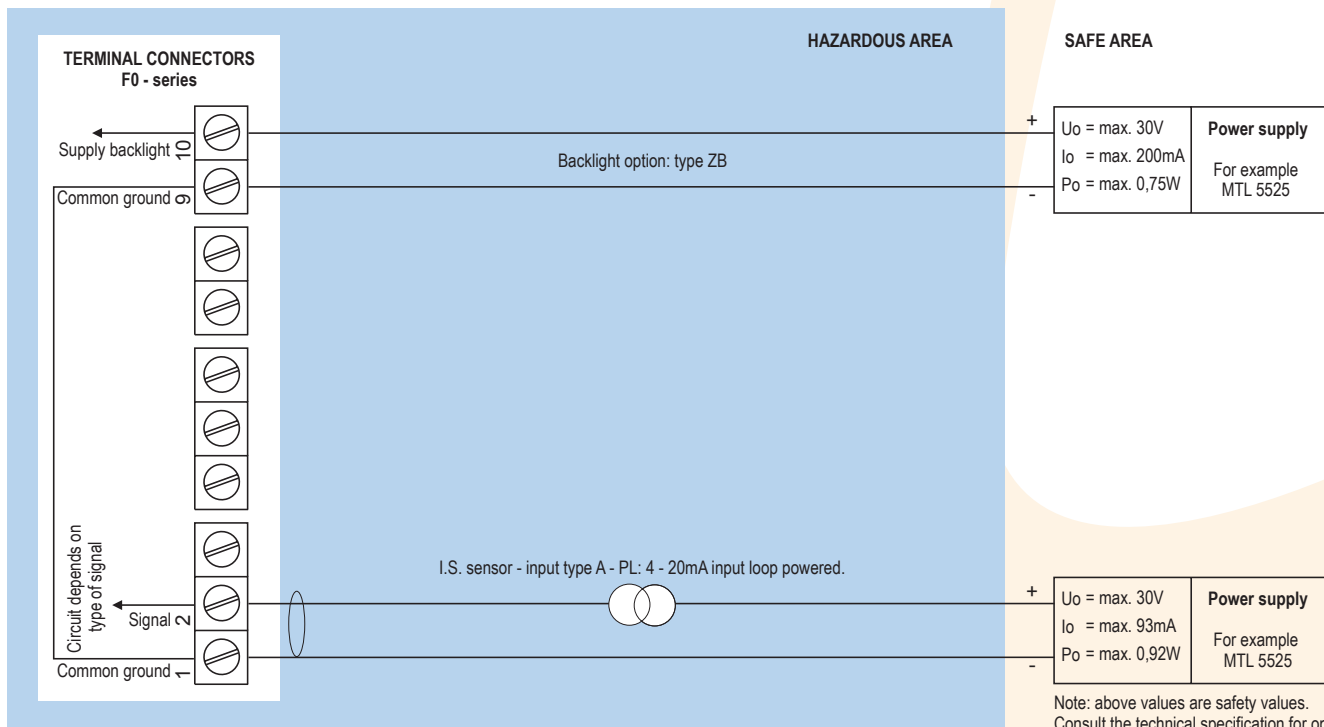

Sensor supply is not available: unit is input loop powered (type PL).

Technical specification

General

Display	
Type	High intensity reflective numeric and alphanumeric LCD, UV-resistant.
Dimensions	90 x 40mm (3.5" x 1.6").
Digits	5½ very large 26mm (1") and eleven 8mm (0.31") digits. Various symbols and measuring units.
Piegraph	10 segment range indication in relation to its measuring range 0 - 100%
Option ZB	Transflective LCD with bi-color LED-backlight; green / amber. Intensity and color selected through the keyboard.

Piegraph	
Digits	10 segments.
Relation	To the min. and max. input signal (0 - 100%).





Operating temperature	
Standard unit	-40°C to +80°C (-40°F to +176°F).
Intrinsically Safe	-40°C to +70°C (-40°F to +158°F).

Power requirements	
Type PL	Input loop powered from sensor signal 4 - 20mA
Type ZB	For backlight 20 - 30V DC. Power consumption max. 1 Watt.
Note	For Intrinsically Safe applications, consult the safety values in the certificate.

Terminal connections	
Type	Removable plug-in terminal strip. Wire max. 1.5mm ² .

Data protection	
Type	EEPROM backup of all settings. Data retention at least 10 years.
Pass-code	Configuration settings can be pass-code protected.

Hazardous area

Intrinsically Safe	
ATEX certification	 II 1 G Ex ia IIC T4. II 1 D Ex iaD 20 IP 65 / 67 T 100 °C.
IECEX certification	 Ga Ex ia IIC T4. Ex iaD 20 IP 65 / 67 T 100 °C.
CSA c-us certification	 Intrinsically Safe for Class I/II/III, Div. 1, Groups A, B, C, D, E, F, G, Temp. class T4 and Class I, Zone o, AEx ia IIC T4.
FM certification	 Intrinsically Safe for Class I/II/III, Div. 1, Groups A, B, C, D, E, F, G, Temp. class T4 and Class I, Zone o, AEx ia IIC T4.
Ambient Ta	-40°C to +70°C (-40°F to +158°F).

Environment	
Electromagnetic compatibility	Compliant ref: EN 61326 (1997), EN 61010-1 (1993).

Signal input

Sensor	
Type A	4 - 20mA. Analog input signal can be scaled to any desired range within 4 - 20mA.
Accuracy	Resolution: 16 bit. Error < 0.01mA / ± 0.05% FS. Low level cut-off programmable.
Span	0.0001 / 199,999 with variable decimal position.
Offset	-99,999 / +199,999 units.
Update time	Four times per second.
Voltage drop	Max. 2.6V DC @ 20mA.
Relationship	Linear and square root calculation.

Casing

General	
Window	Polycarbonate window.
Sealing	Silicone.
Control keys	Three industrial micro-switch keys. UV-resistant silicone keypad.

Aluminum wall / field mount enclosures	
General	Die-cast aluminum wall/field mount enclosure IP67 / NEMA 4X with 2-component UV-resistant coating.
Dimensions	130 x 120 x 75mm (5.12" x 4.72" x 2.95") - W x H x D.
Weight	1100 gr.
Type HA	Cable entry: 2 x PG9 and 1 x M20.
Type HM	Cable entry: 2 x M16 and 1 x M20.
Type HN	Cable entry: 1 x M20.
Type HO	Cable entry: 2 x M20.
Type HP	Cable entry: 6 x M12.
Type HT	Cable entry: 1 x ½" NPT.
Type HU	Cable entry: 3 x ½" NPT.
Type HV	Cable entry: 4 x M20.
Type HZ	Cable entry: no holes.

GRP wall / field mount enclosures	
General	GRP wall/field mount enclosure IP67 / NEMA 4X, UV-resistant and flame retardant.
Dimensions	130 x 120 x 75mm (5.12" x 4.72" x 2.95") - W x H x D.
Weight	600 gr.
Type HD	Cable entry: no holes.
Type HE	Cable entry: 2 x Ø 16mm and 1 x Ø 20mm.
Type HF	Cable entry: 1 x Ø 22mm (7/8").
Type HG	Cable entry: 2 x Ø 20mm.
Type HH	Cable entry: 6 x Ø 12mm.
Type HJ	Cable entry: 3 x Ø 22mm (7/8").
Type HK	Flat bottom, cable entry: no holes.

Panel mount enclosures	
Dimensions	130 x 120 x 60mm (5.12" x 4.72" x 2.36") - W x H x D.
Panel cut-out	115 x 98mm (4.53" x 3.86") L x H.
Type HB	Die-cast aluminum panel mount enclosure IP65 / NEMA 4X.
Weight	600 gr.
Type HC	GRP panel mount enclosure IP65 / NEMA 4X, UV-resistant and flame retardant.
Weight	450 gr.

ABS wall / field mount enclosures	
General	Silicone free ABS wall/field mount enclosure IP65 with EPDM and PE sealings. UV-resistant polyester keypad (old HD enclosure).
Dimensions	130 x 114 x 71mm (5.1" x 4.5" x 2.8") - W x H x D.
Weight	450 gr.
Type HS	Cable entry: no holes.

























Operational

Operator functions	
Displayed functions	<ul style="list-style-type: none"> • Top line: main display value. • Bottom line: measuring unit and messages. • Piegraph: 10 segments related to input signal. • Actual sensor input value in mA. • Displayed value at 0% of the input signal. • Displayed value at 100% of the input signal.

Total	
Digits	5½ digits (height 26mm / 1").
Units	m - mL - L - nL - M ³ - nM ³ - mg - g - kg - ton - gal - sgal - igal - lb - bbl - cf - scf - p - rev - °C - °F - °K - % - mm - cm - mtr - inch - ft - mmwk - mmwc - cmwk - cmwc - mwk - mwc - inwc - ftwc - mbar - bar - psi - pH - mV - no unit.
Time units	/sec - /min - /hr - /day - no unit.
Decimals	0 - 1 - 2 - 3 - 4 or 5.

Ordering information

Standard configuration: Fogo-A-HC-PL-XX-ZX.

ordering information:	F090	-A	-H	-PL	-X	-Z
Sensor input signal						
A 	4 - 20mA input.					
Panel mount enclosures - IP65 / NEMA4X						
HB 	Aluminum enclosure.					
HC 	GRP enclosure.					
GRP field / wall mount enclosures - IP67 / NEMA4X						
HD 	Cable entry: no holes.					
HE 	Cable entry: 2 x Ø 16mm & 1 x Ø 20mm.					
HF 	Cable entry: 1 x Ø 22mm (7/8").					
HG 	Cable entry: 2 x Ø 20mm.					
HH 	Cable entry: 6 x Ø 12mm.					
HJ 	Cable entry: 3 x Ø 22mm (7/8").					
HK 	Flat bottom, cable entry: no holes.					
Aluminum field / wall mount enclosures - IP67 / NEMA4X						
HA 	Cable entry: 2 x PG9 + 1 x M20.					
HM 	Cable entry: 2 x M16 + 1 x M20.					
HN 	Cable entry: 1 x M20.					
HO 	Cable entry: 2 x M20.					
HP 	Cable entry: 6 x M12.					
HT 	Cable entry: 1 x 1/2" NPT.					
HU 	Cable entry: 3 x 1/2" NPT.					
HV 	Cable entry: 4 x M20.					
HZ 	Cable entry: no holes.					
ABS field / wall mount enclosures - IP65						
HS 	Silicone free ABS field enclosure – Cable entry: no holes (old HD enclosure).					
Power supply						
PL 	Input loop powered from sensor signal 4 - 20mA (type A).					
Hazardous area						
XI 	Intrinsically Safe, according ATEX, IECEx, CSA c-us and FM.					
XX	Safe area only.					
Other options						
ZB 	Backlight.					
ZX 	No options.					

The bold marked text contains the standard configuration.

 Available Intrinsically Safe.

Specifications are subject to change without notice.



Fluidwell bv
 P.O. Box 6
 5460 AA - Veghel - The Netherlands
 Tel.: +31 (0)413 343786
 Fax.: +31 (0)413 363443
 sales@fluidwell.com
 Internet: www.fluidwell.com

